

Prospettiva di una retta obliqua posta sul geometricale

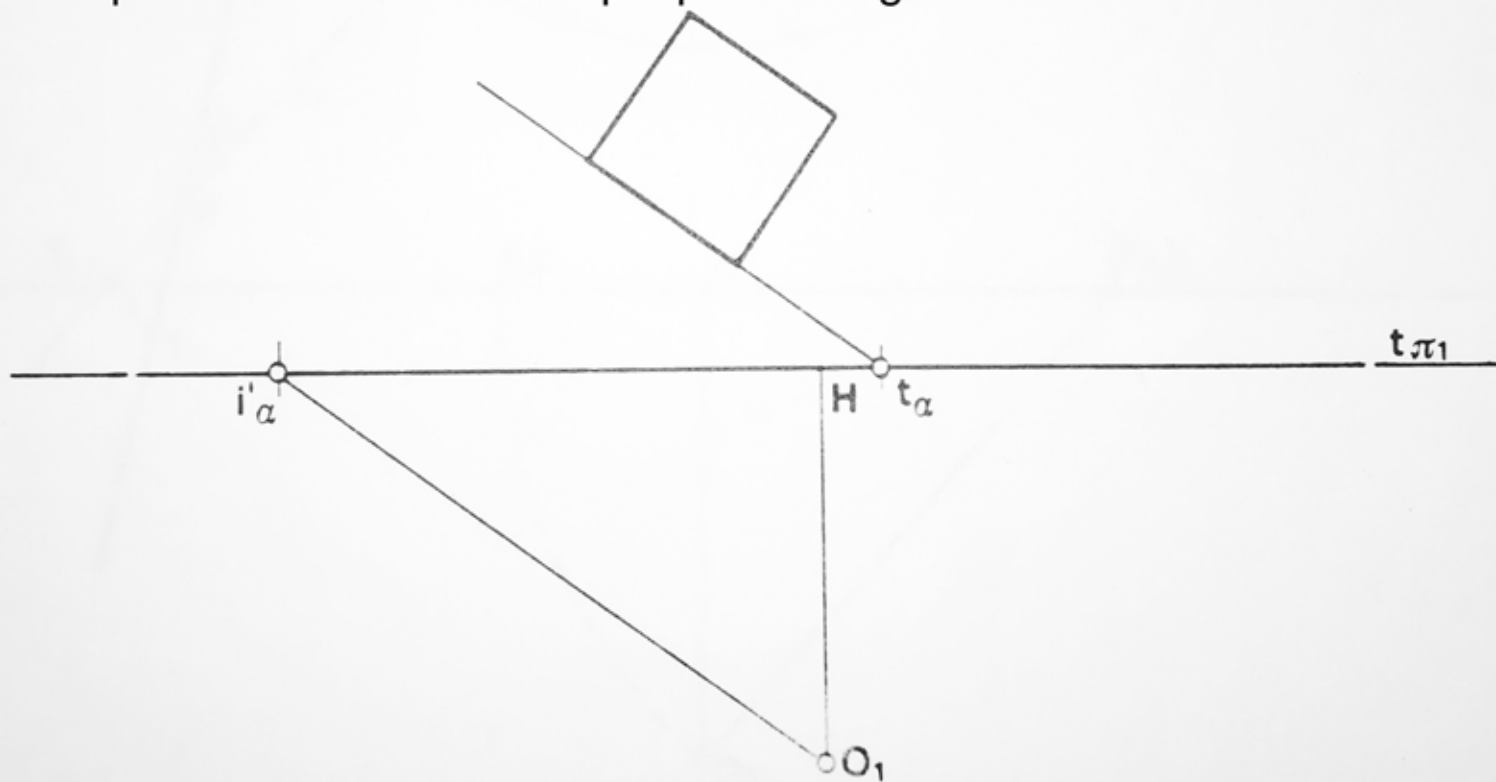

Prospettiva di una retta r a una certa altezza dal geometricale

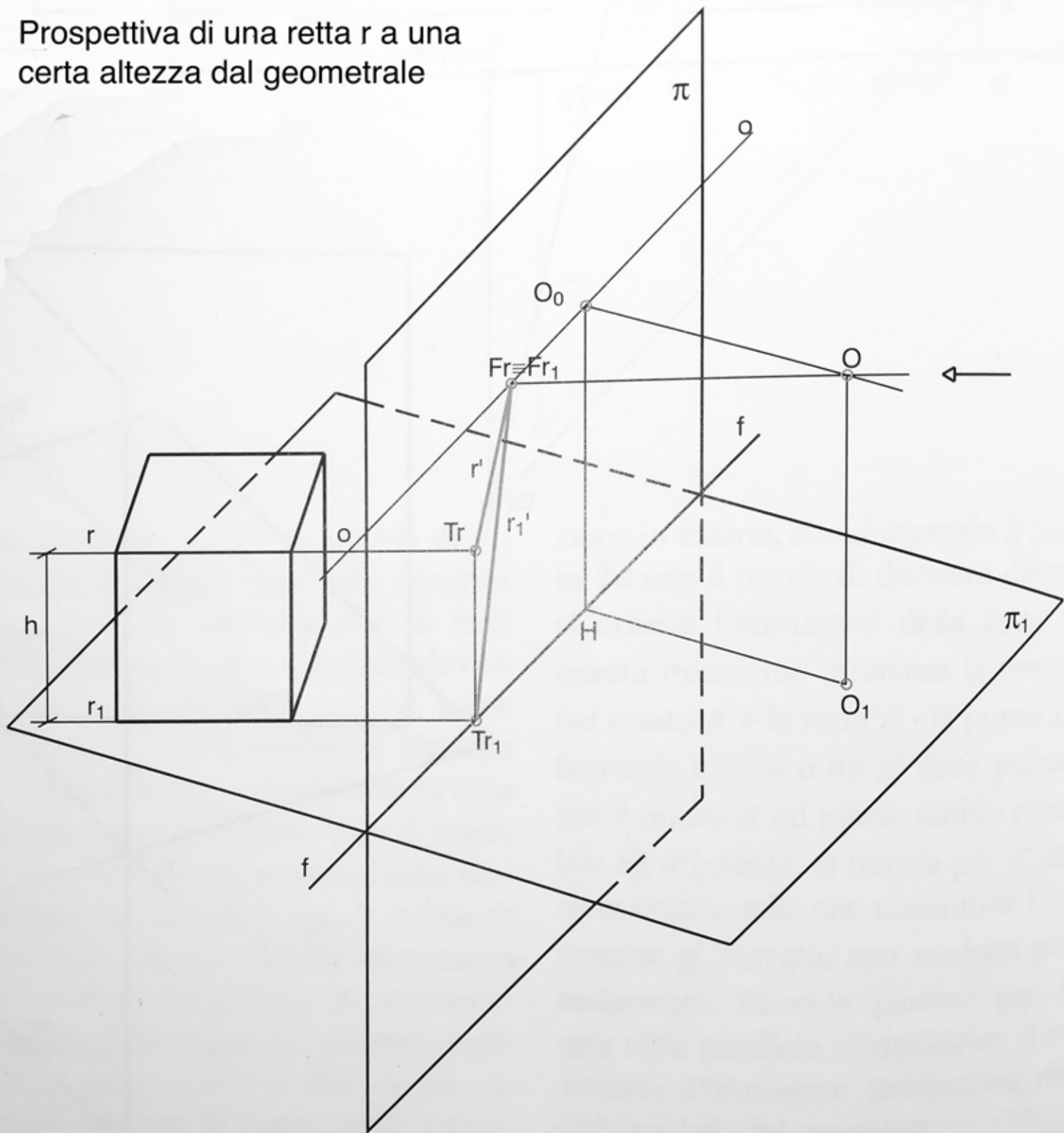

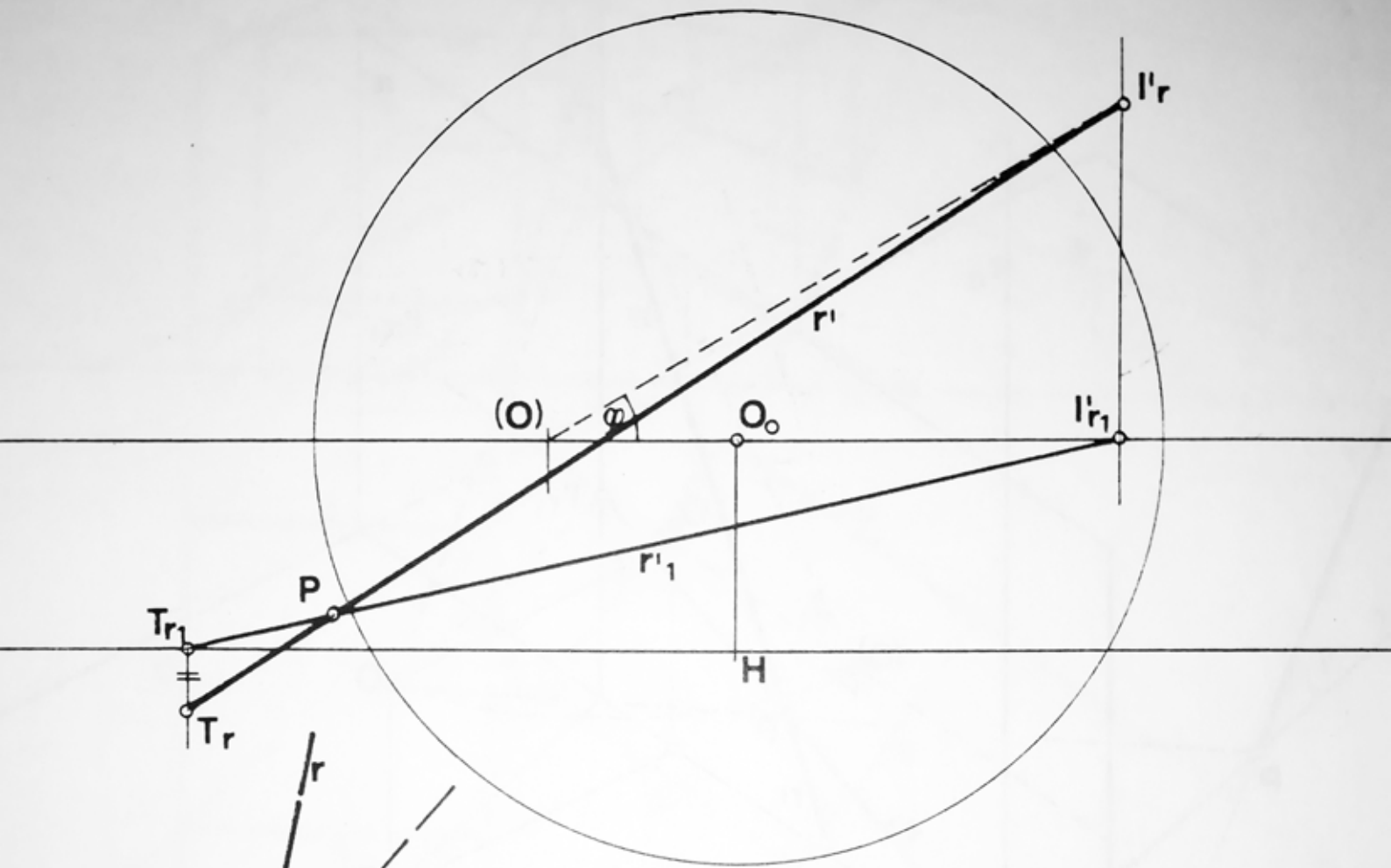

Prospettiva di una retta generica

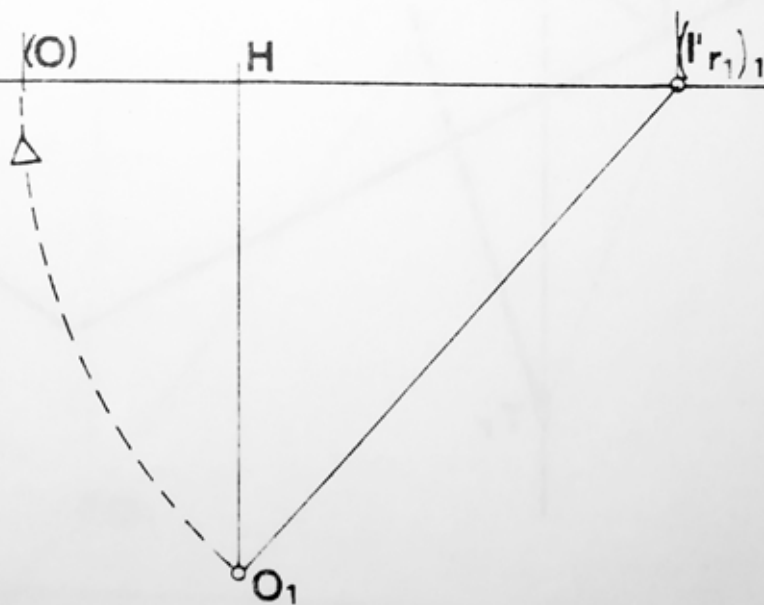

Prospettiva di una retta generica di angolo dato α

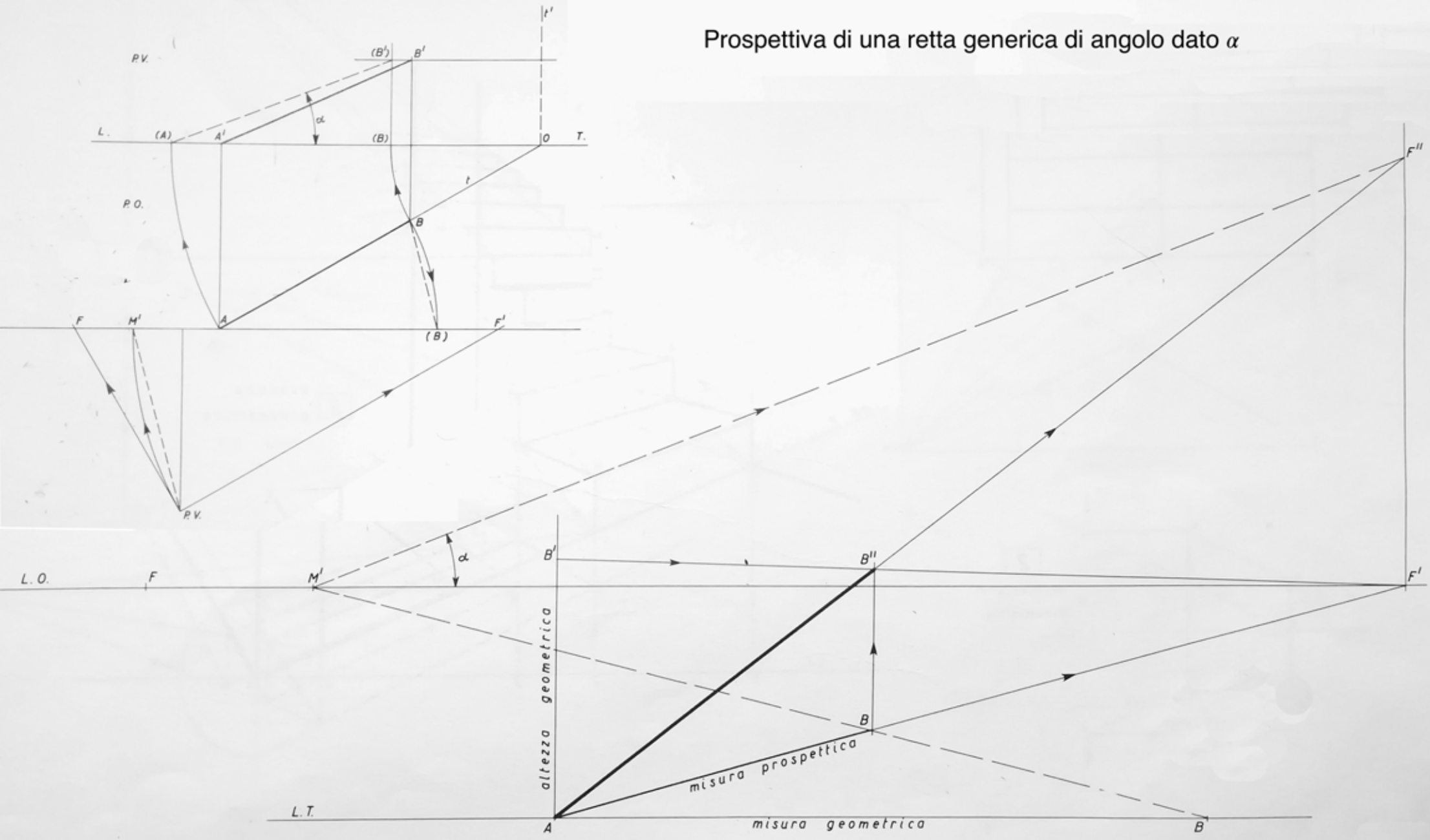

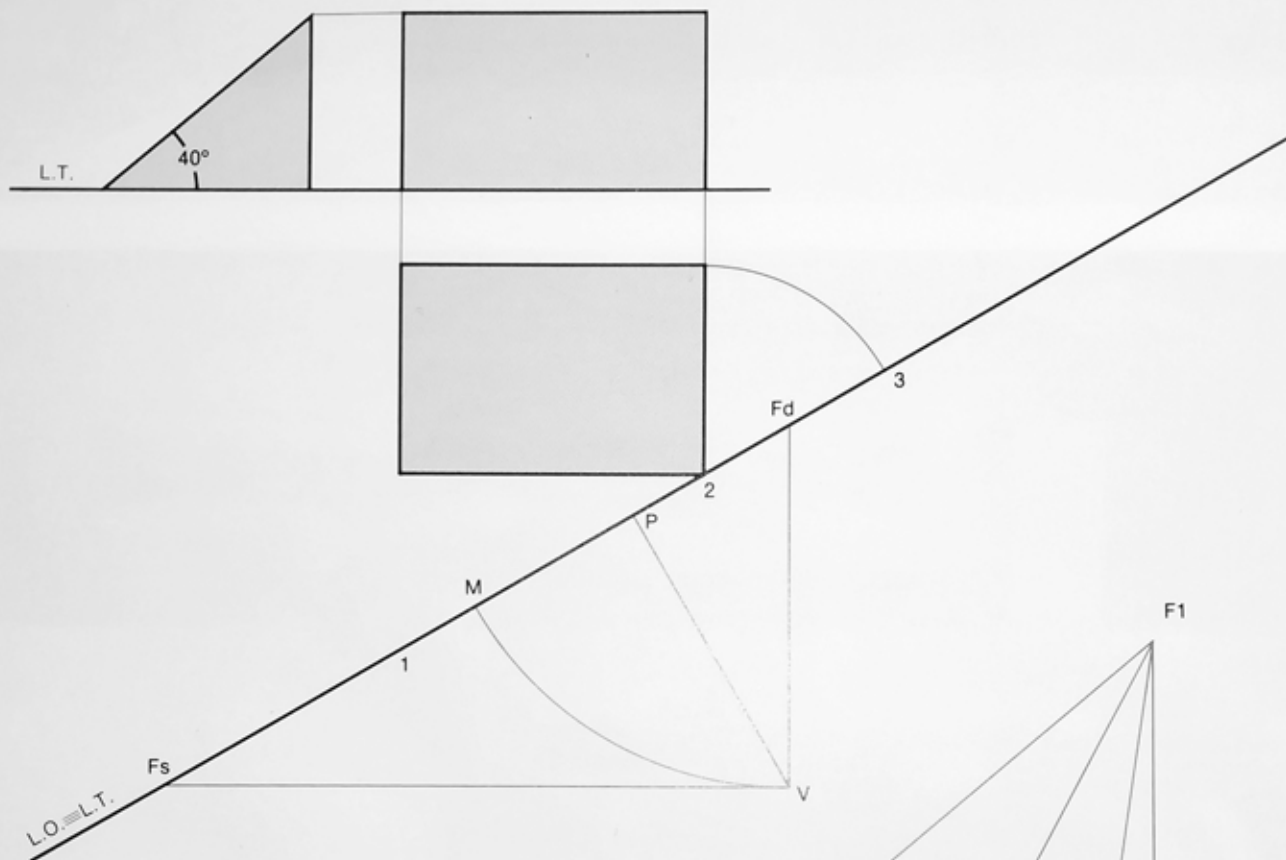

Prospettiva di un piano inclinato di 40°

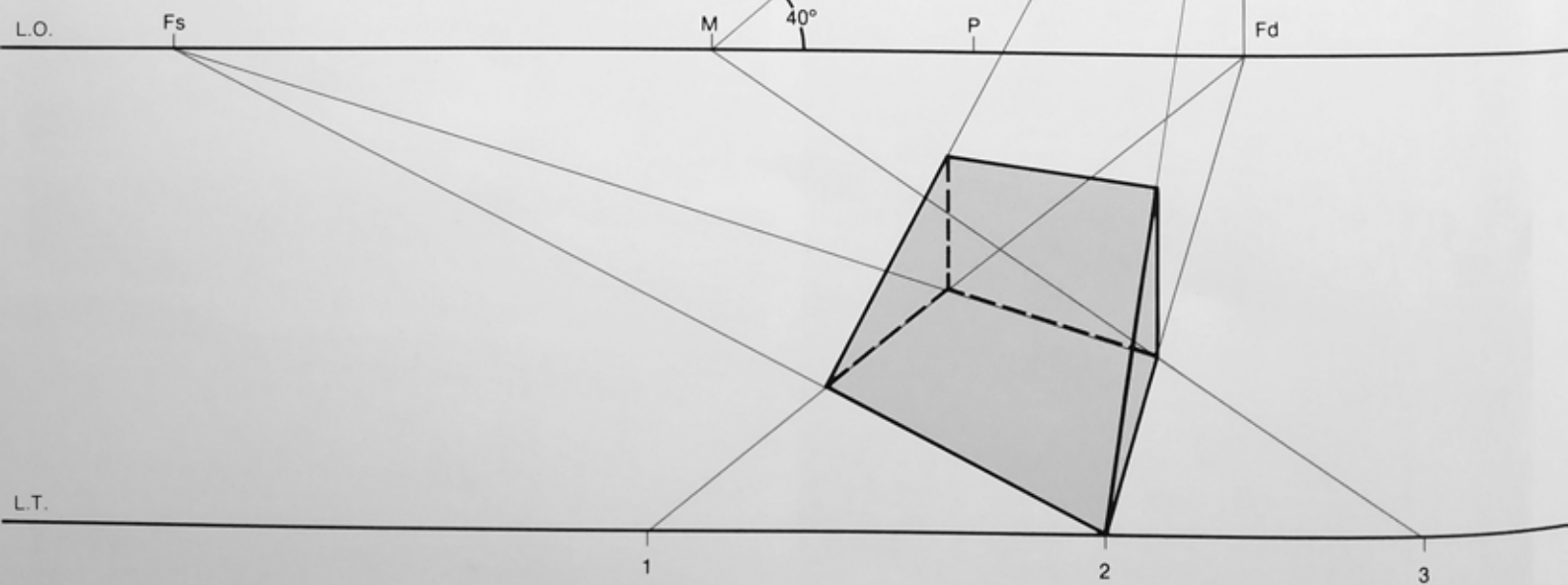

1: Retta r appartenente al geometrale

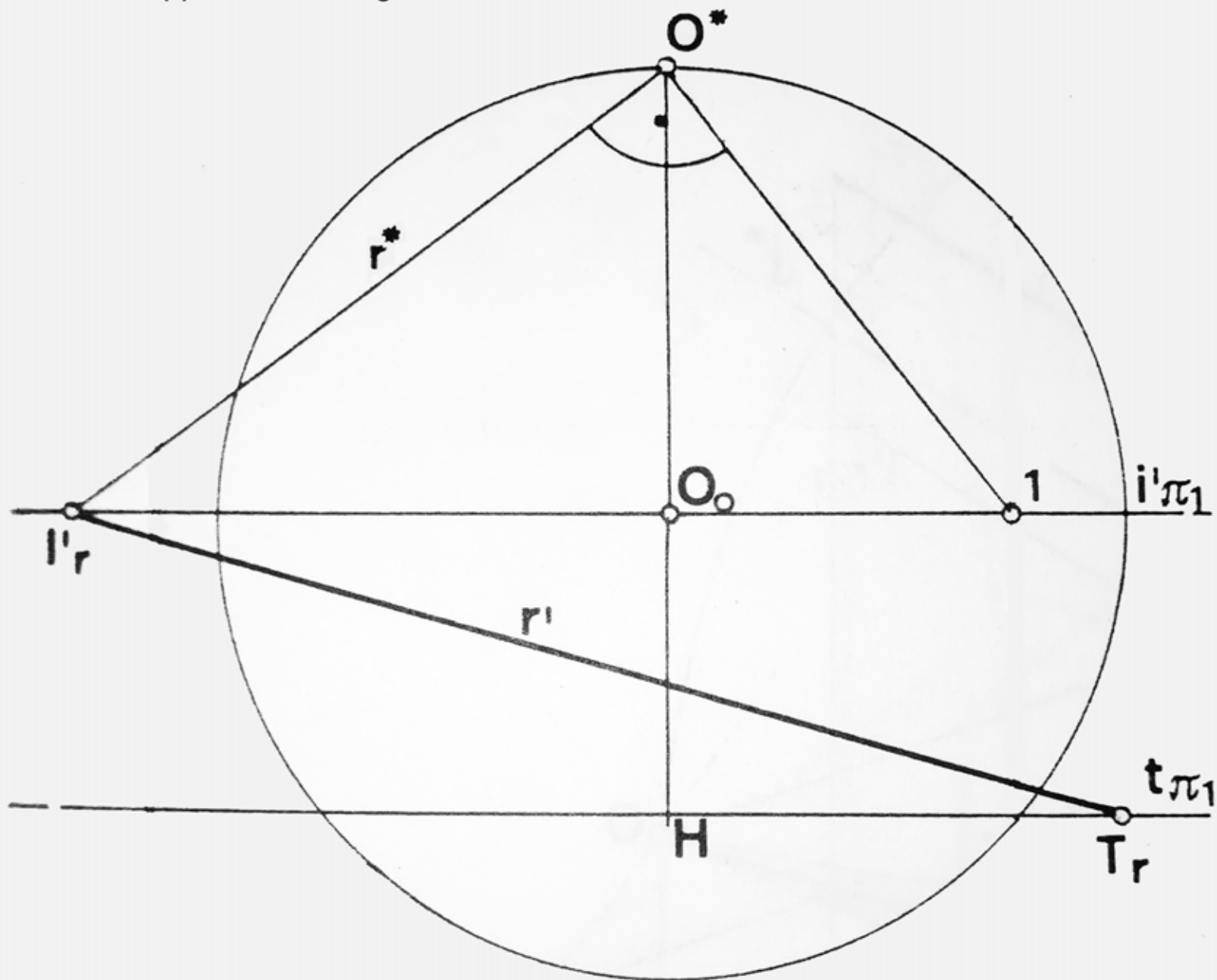

2: Prospettiva di due rette perpendicolari

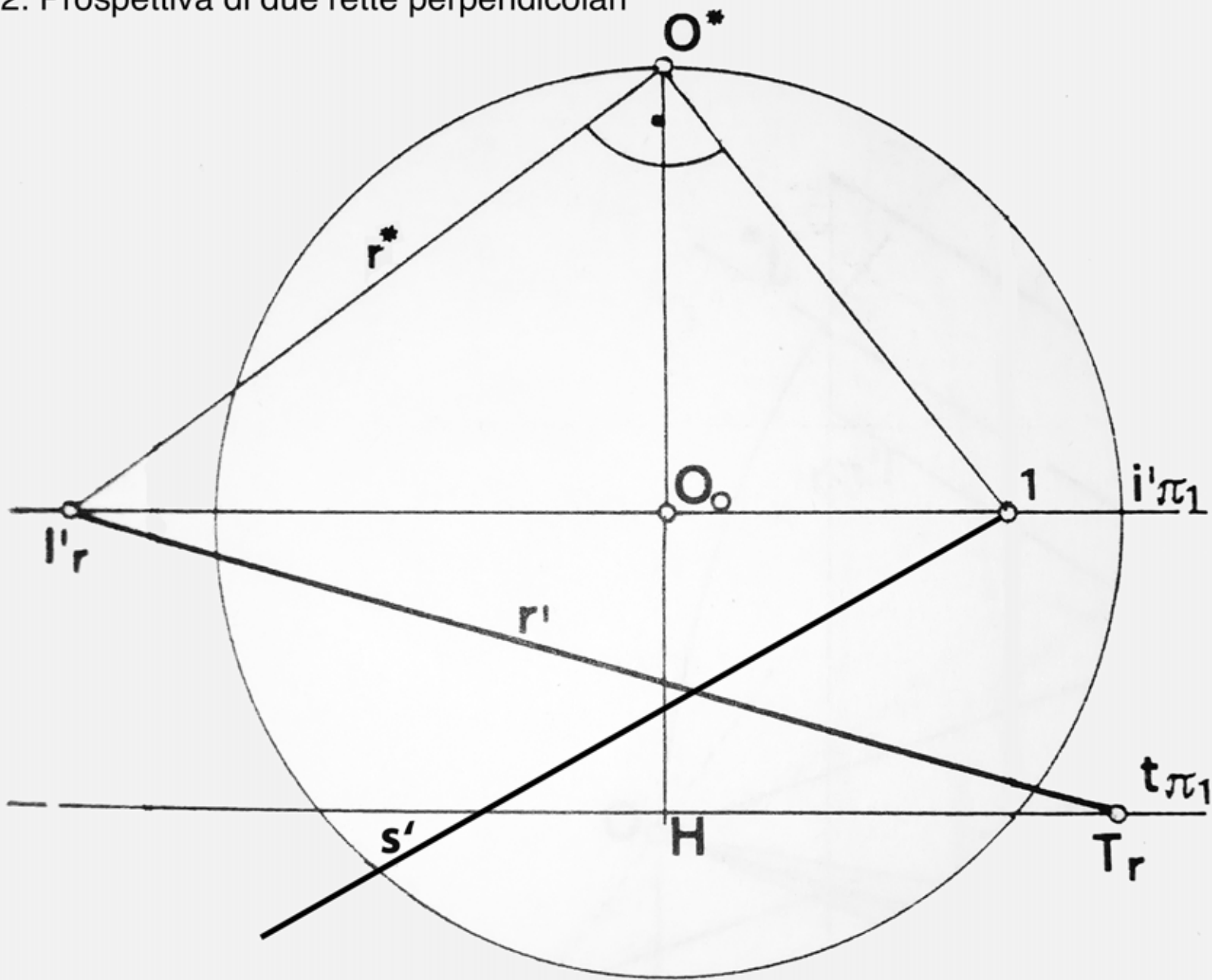

Posizione dell'oggetto rispetto al quadro e all'osservatore

