

Doppia Proiezione di un cerchio parallelo a π' .

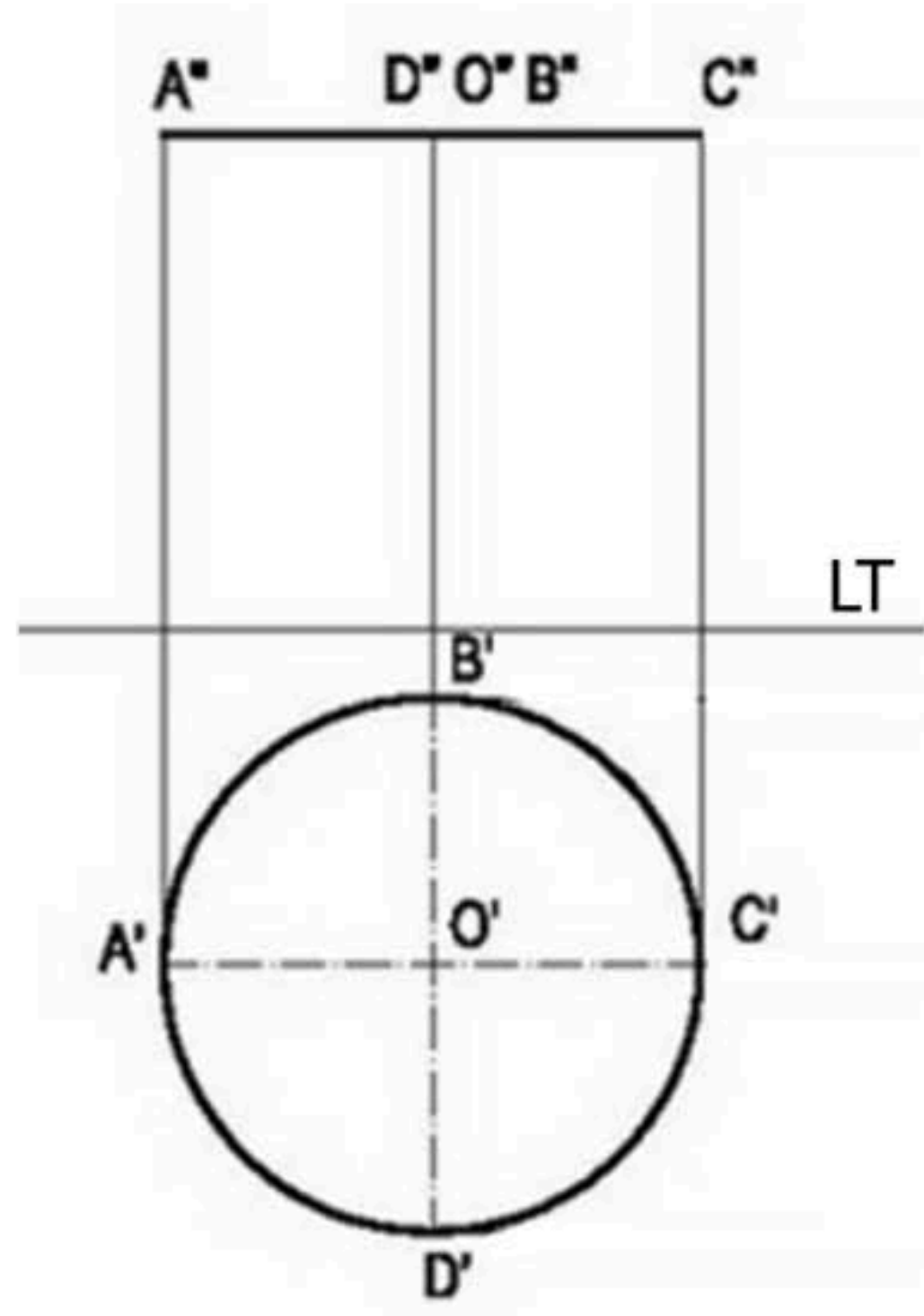

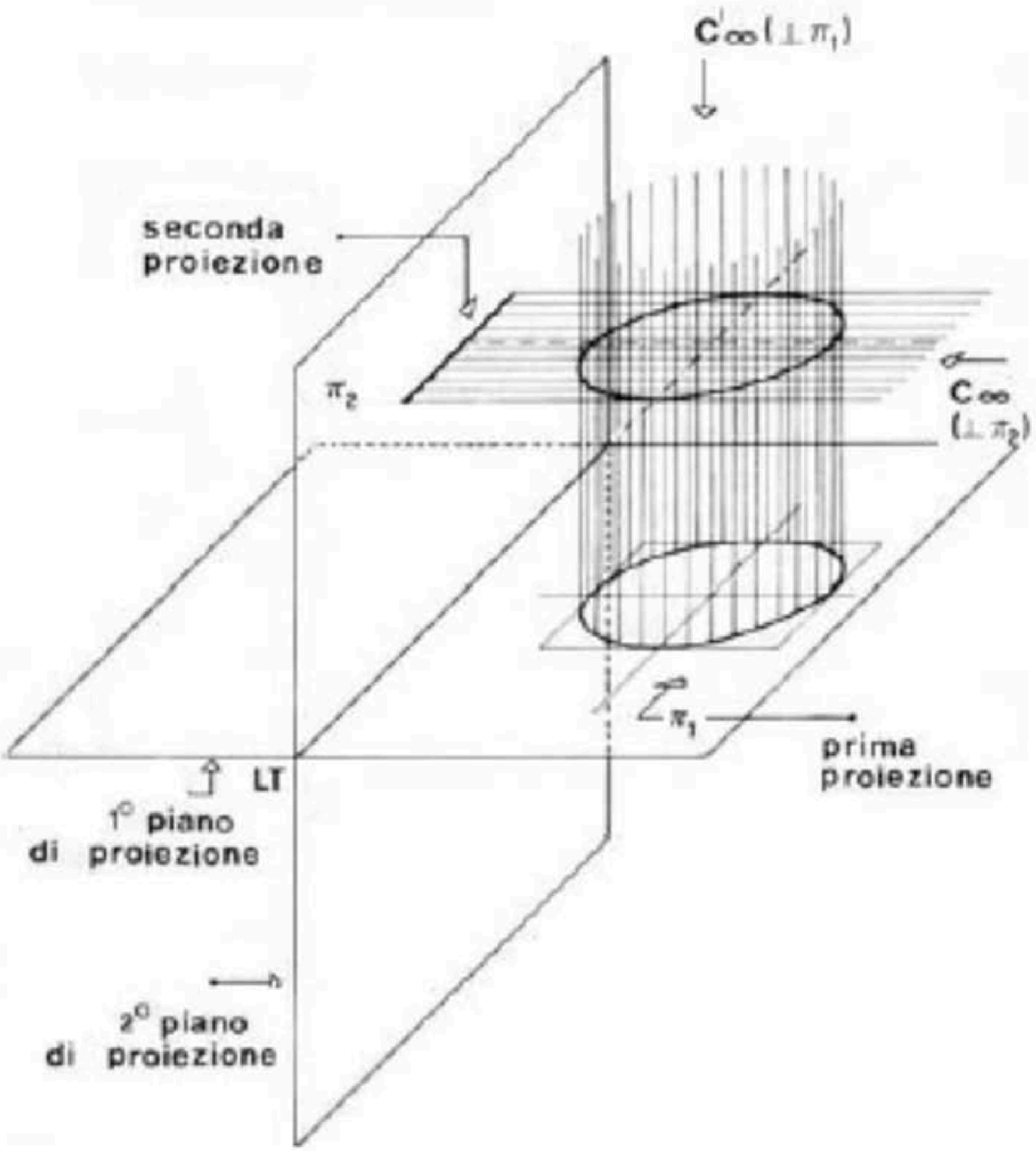

Doppia Proiezione di un punto

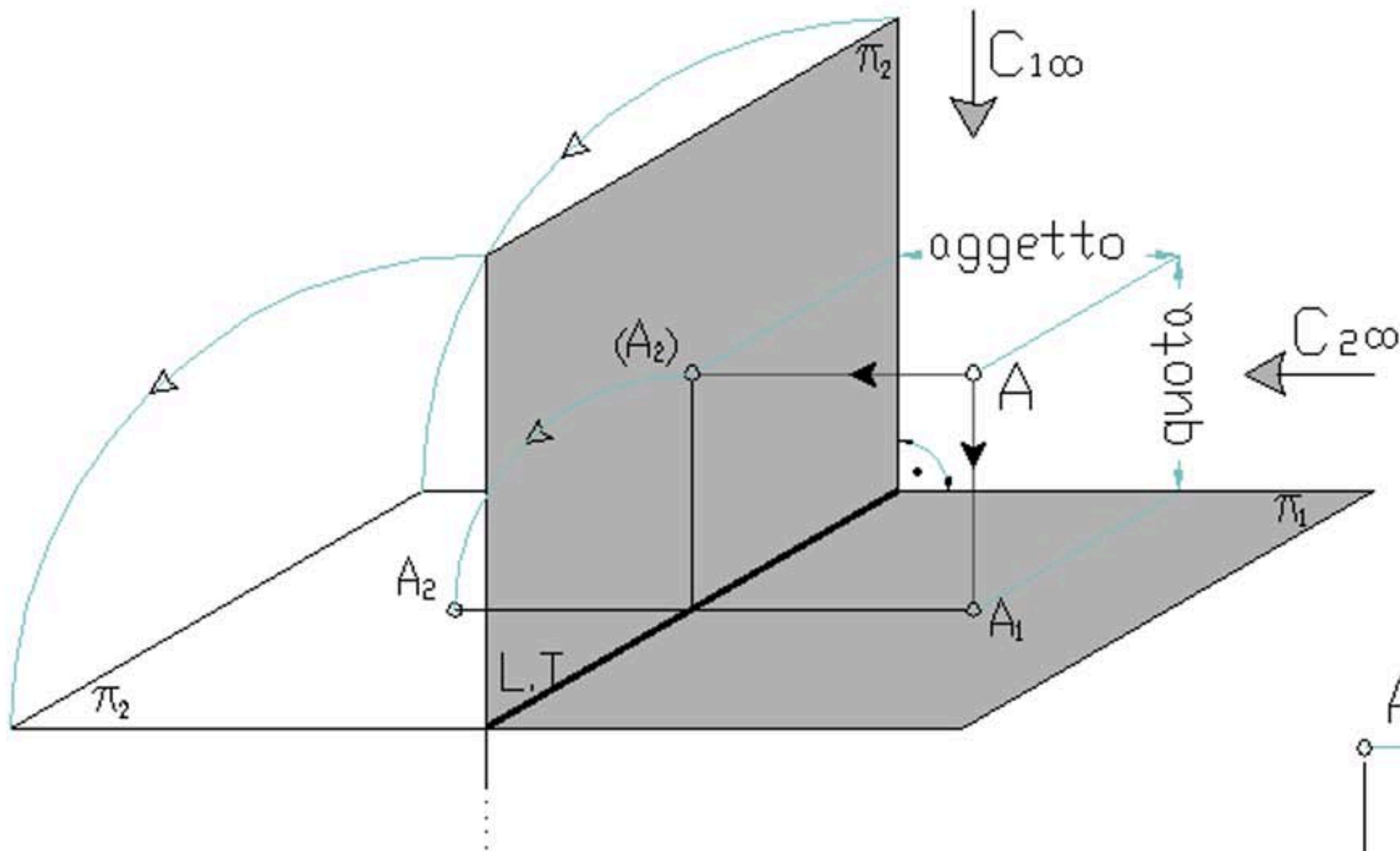
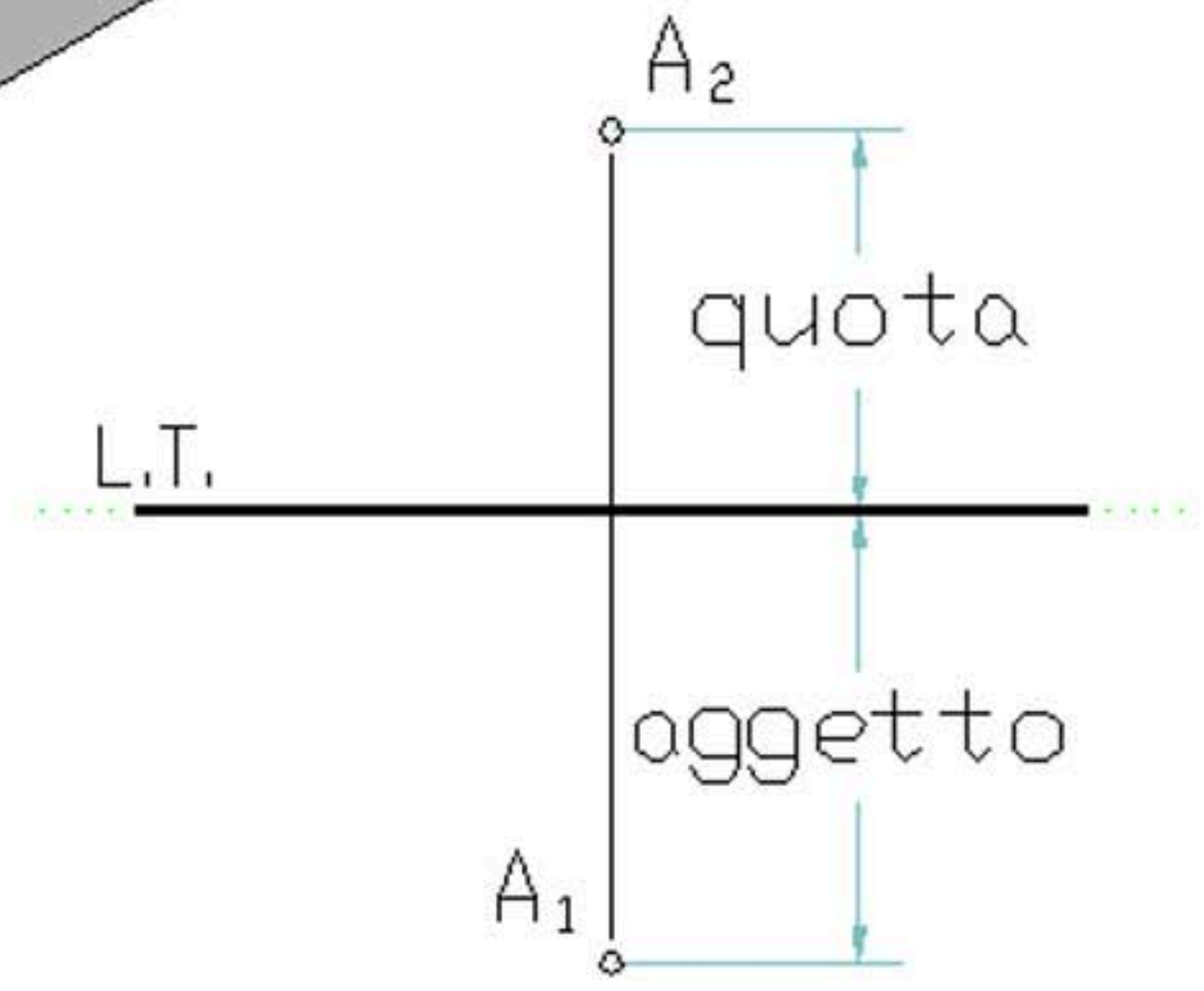

Doppia Proiezione di un punto appartenente a π'

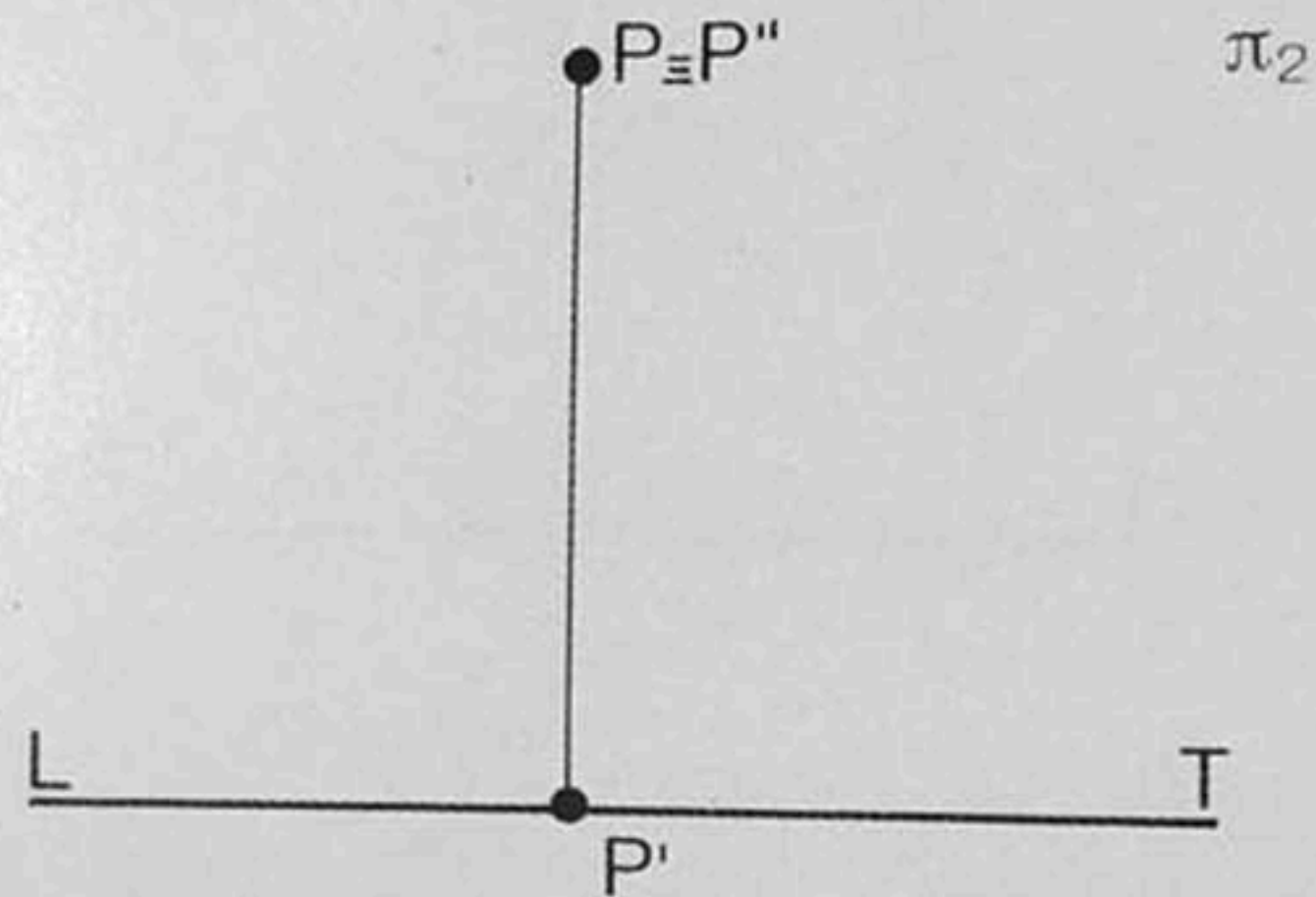
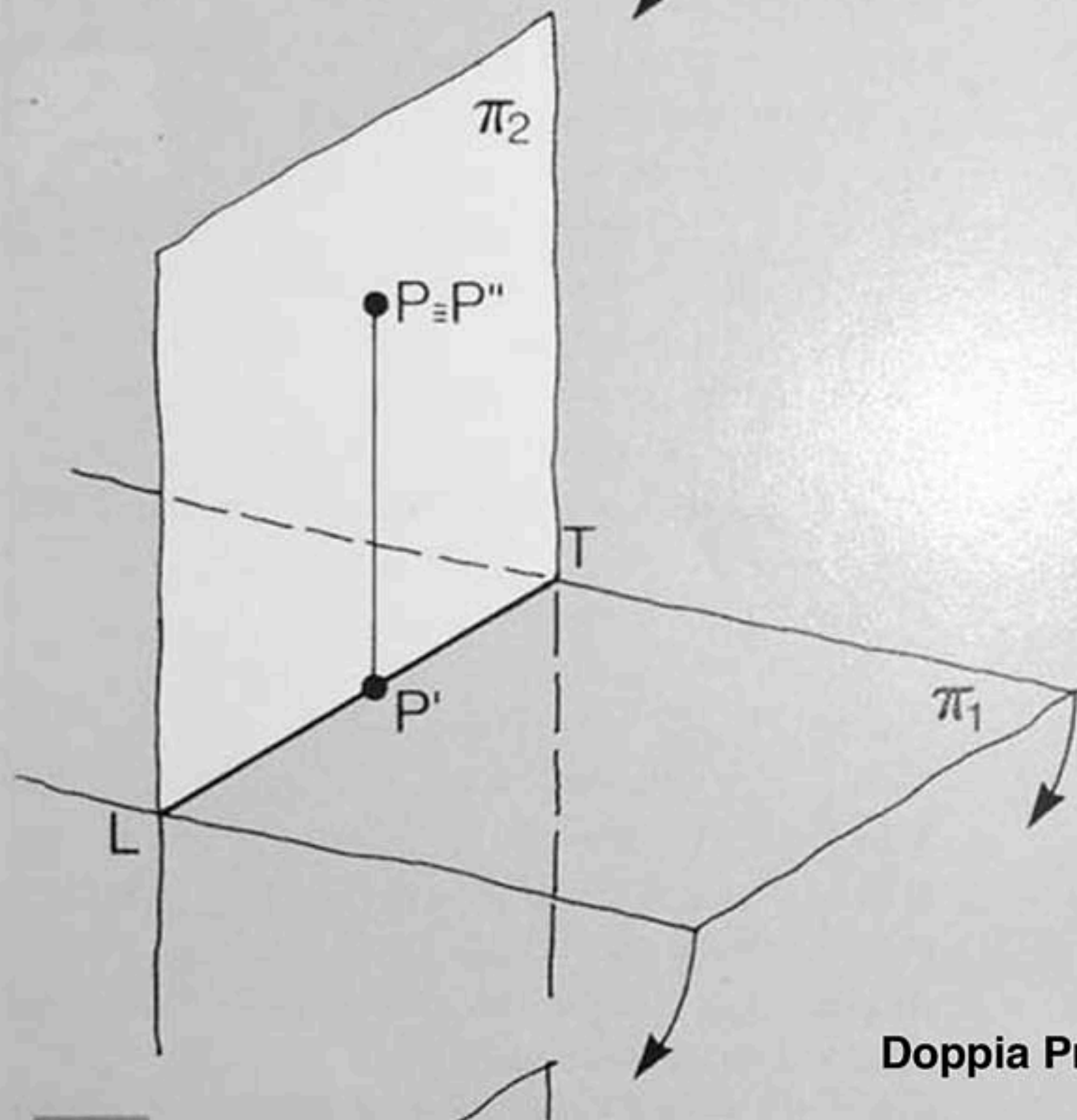
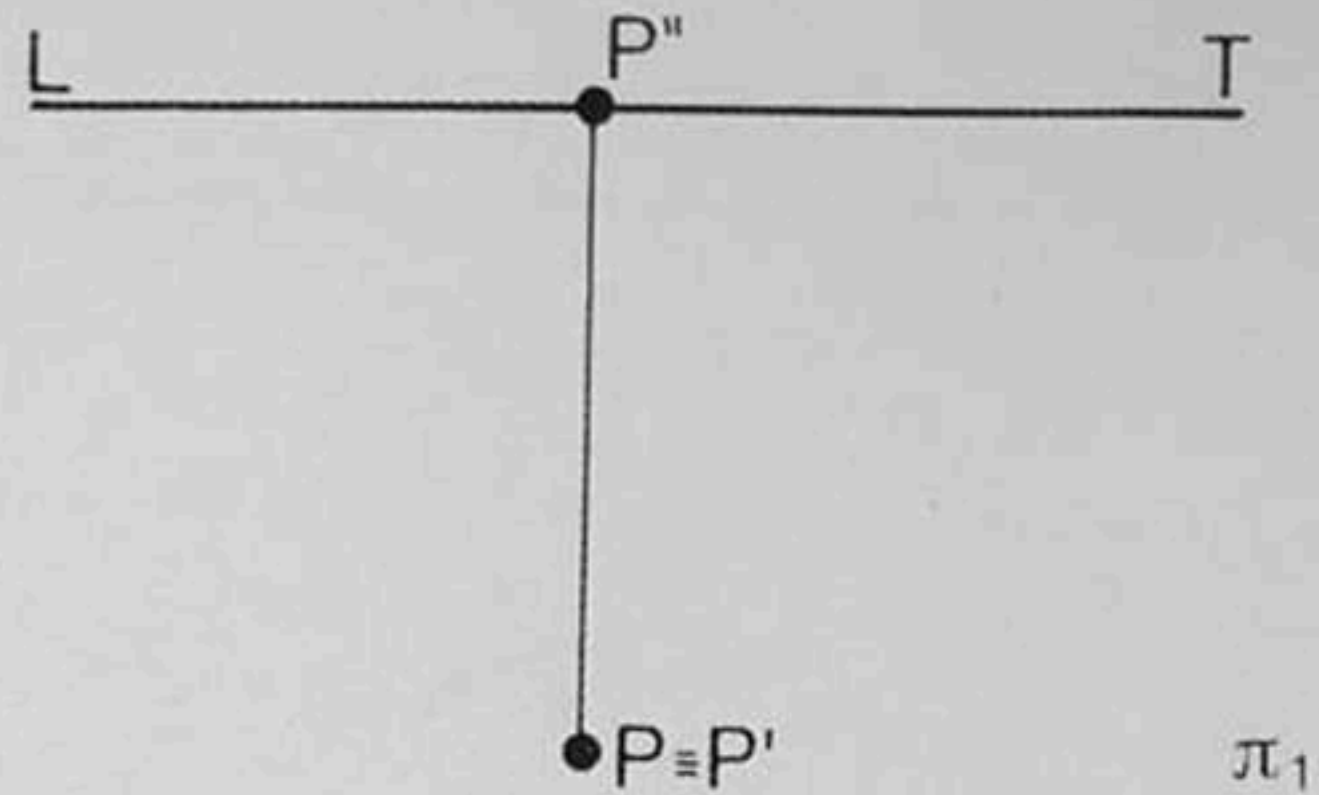
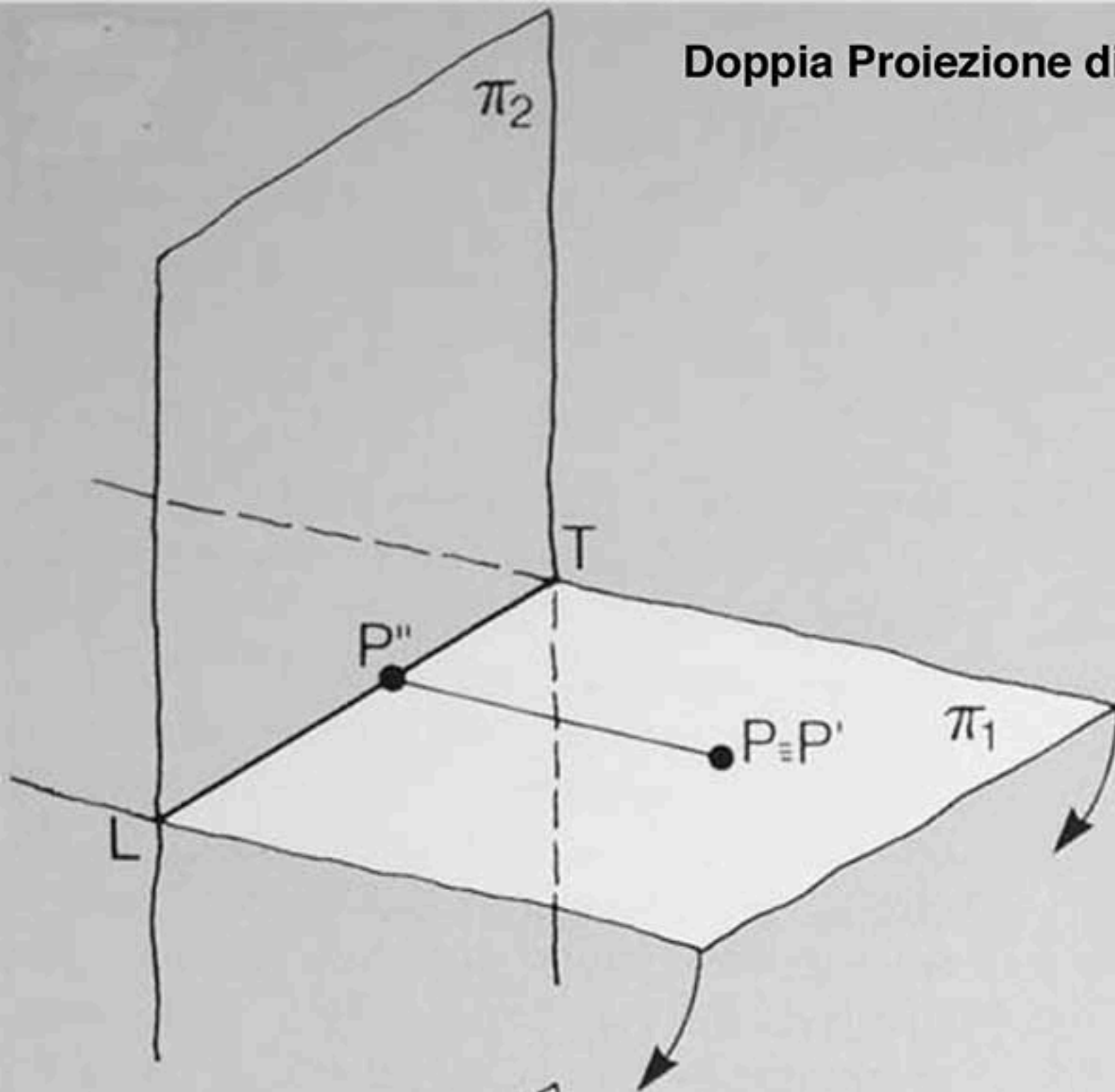

Doppia Proiezione di un punto appartenente a π''

π_1

Doppie proiezioni di segmenti

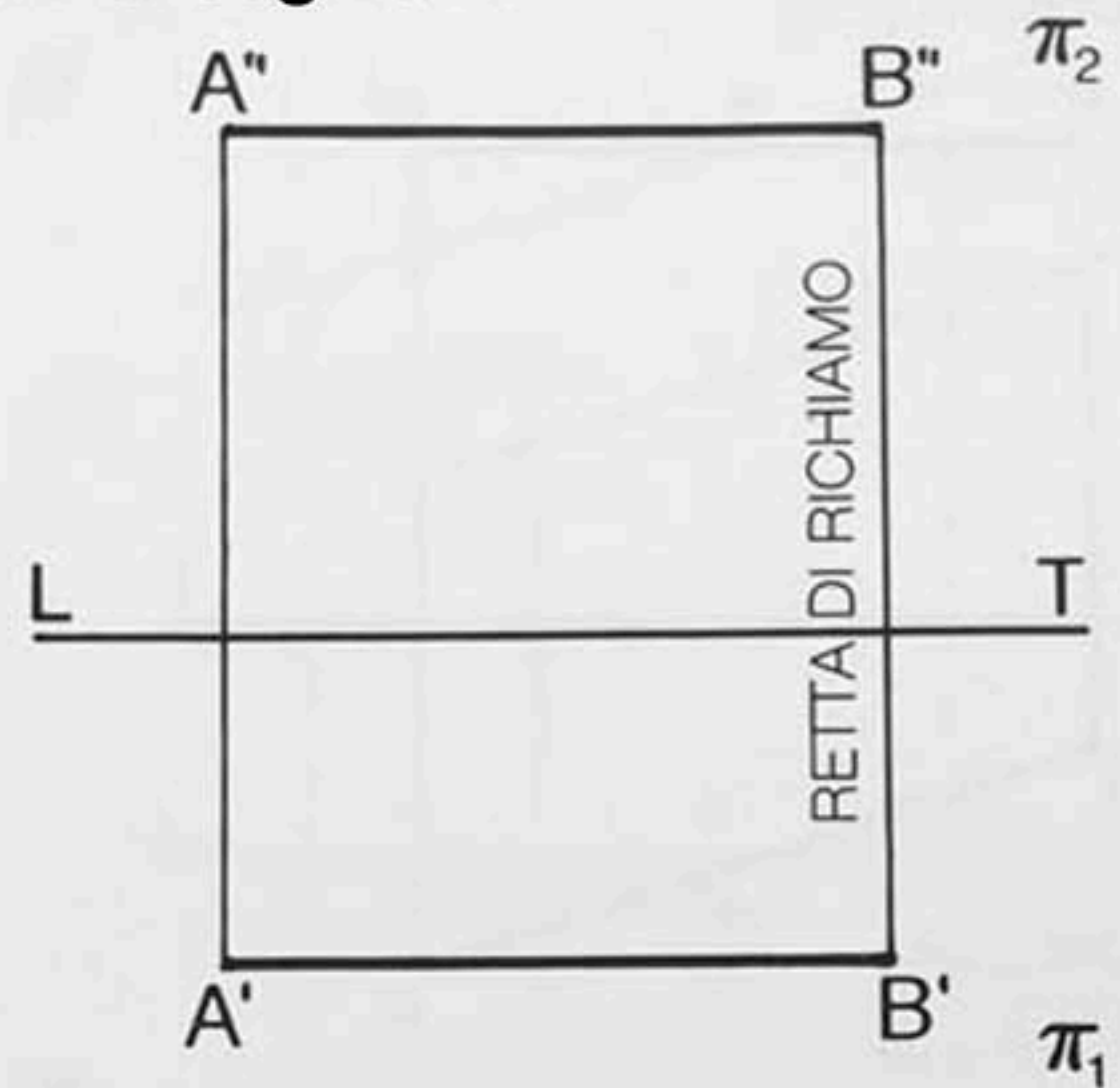
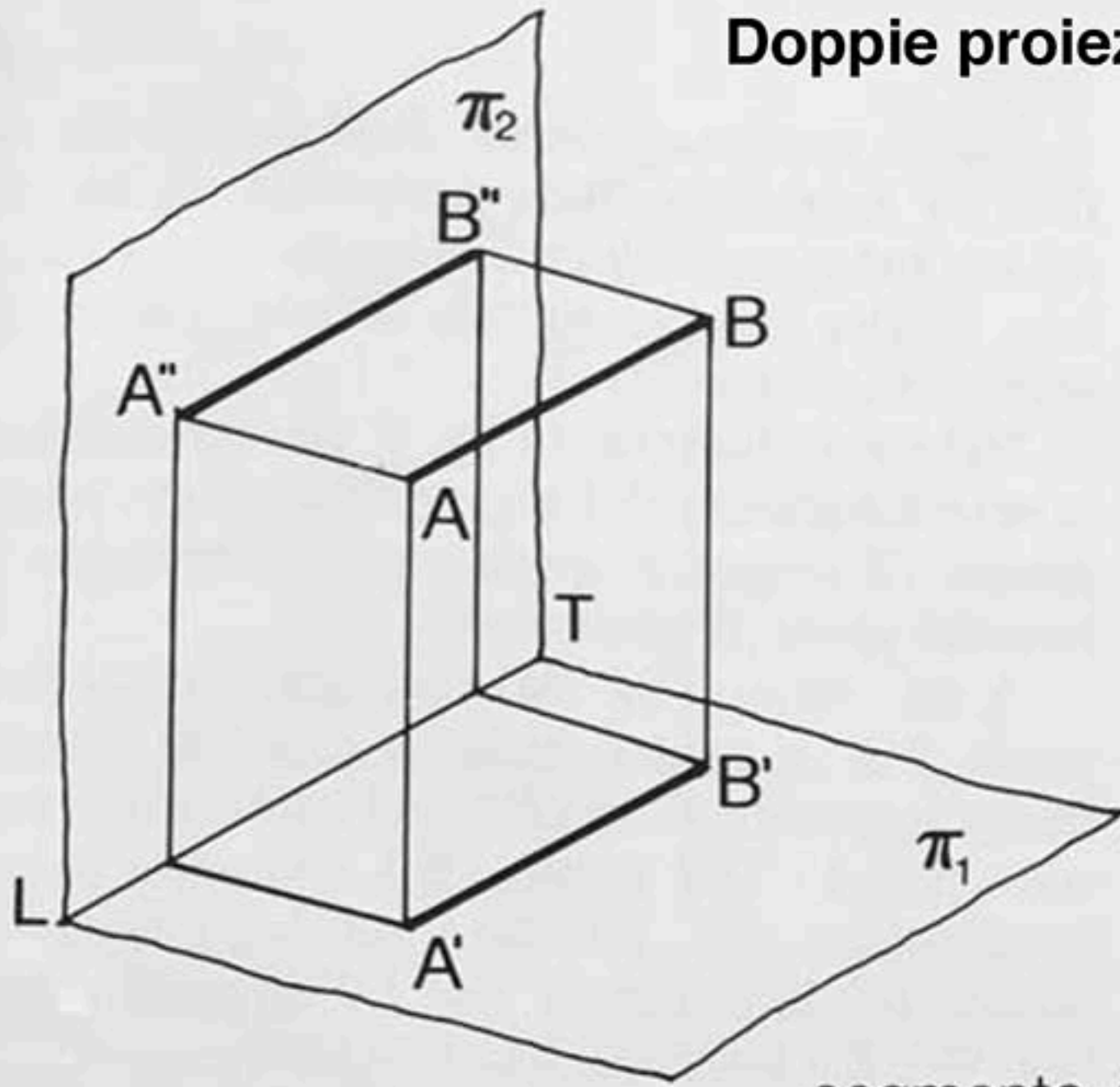

segmento // a π_1 e π_2

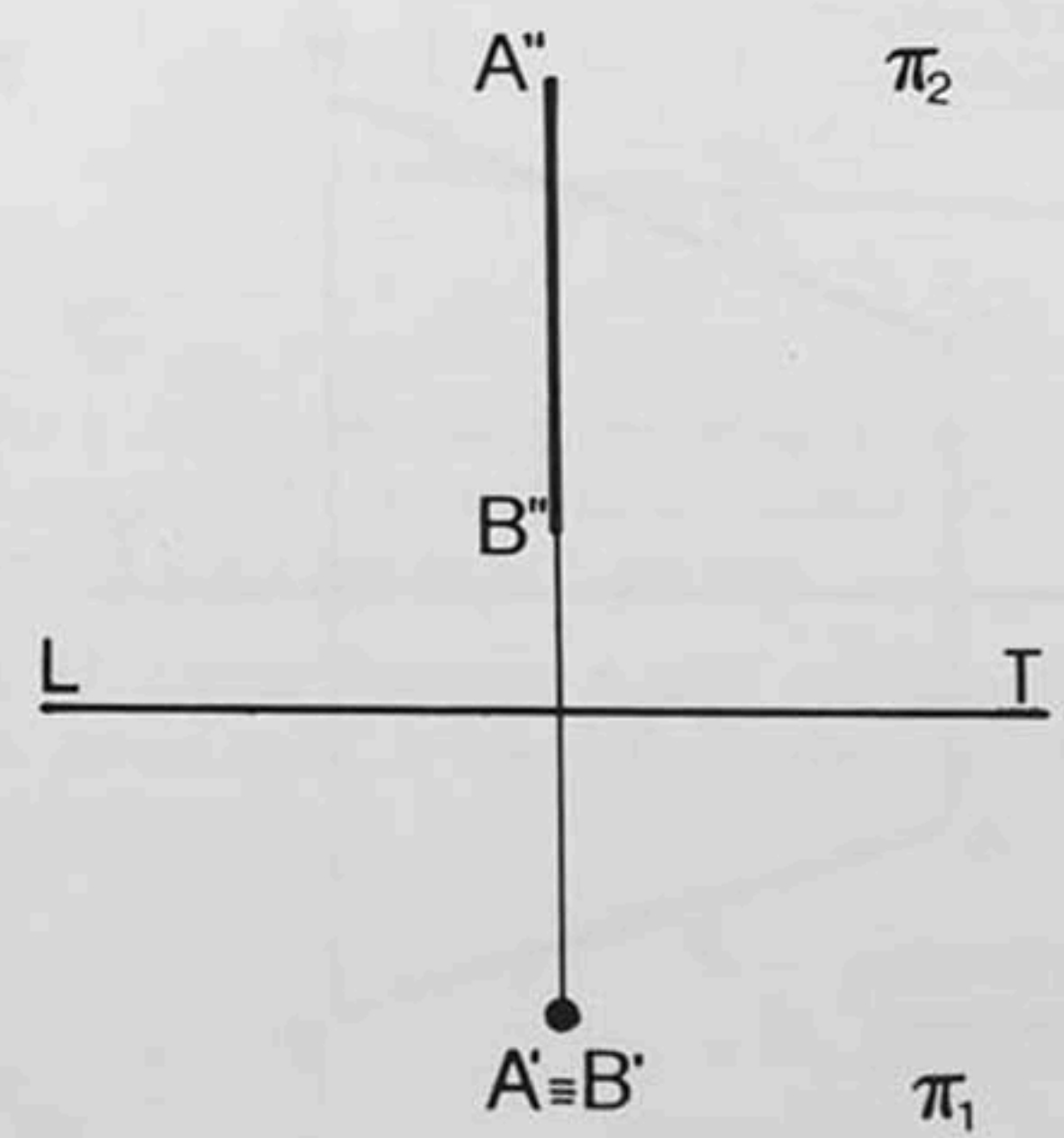
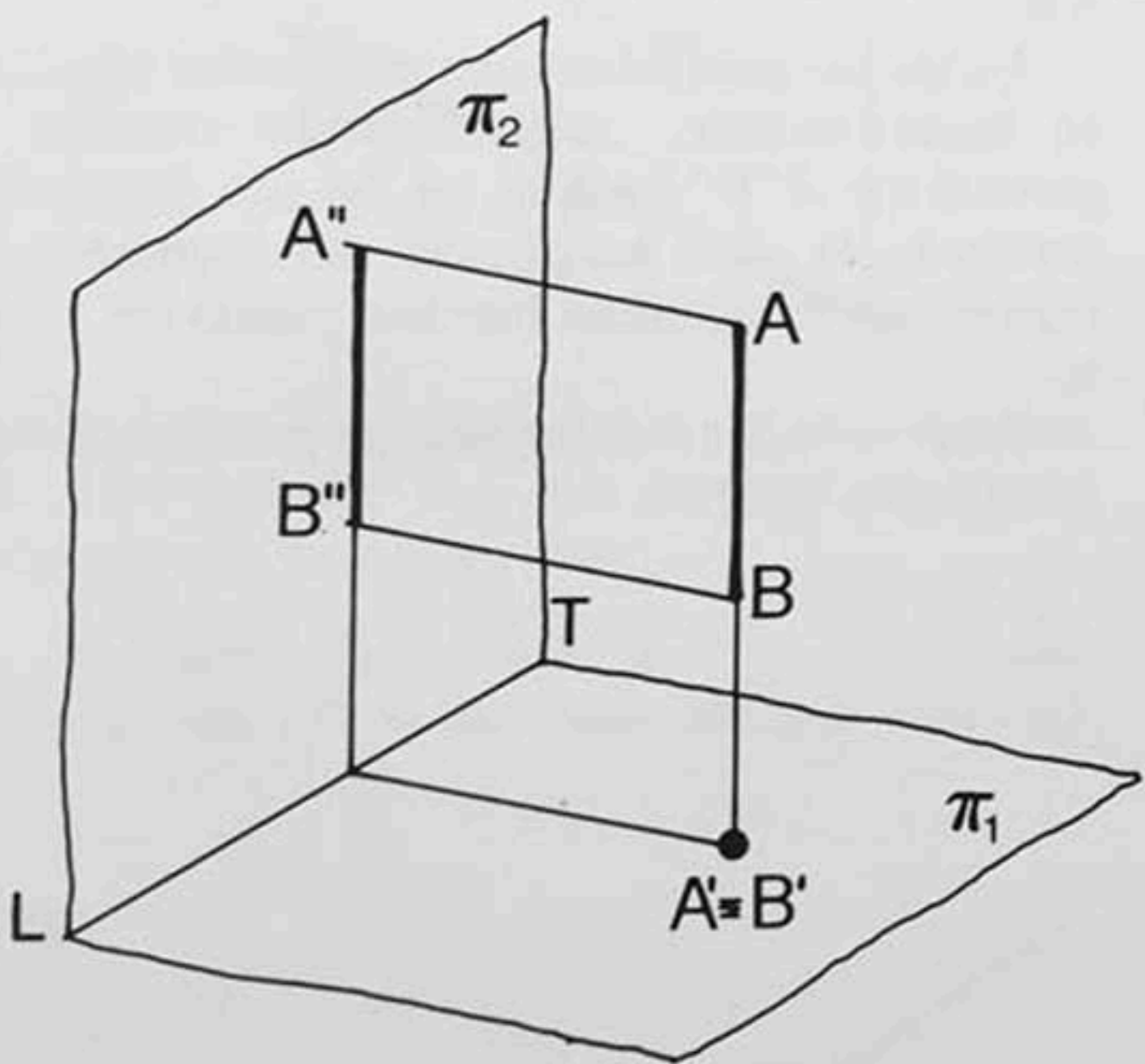

segmento \perp a π_1

Doppia Proiezione di una retta generica

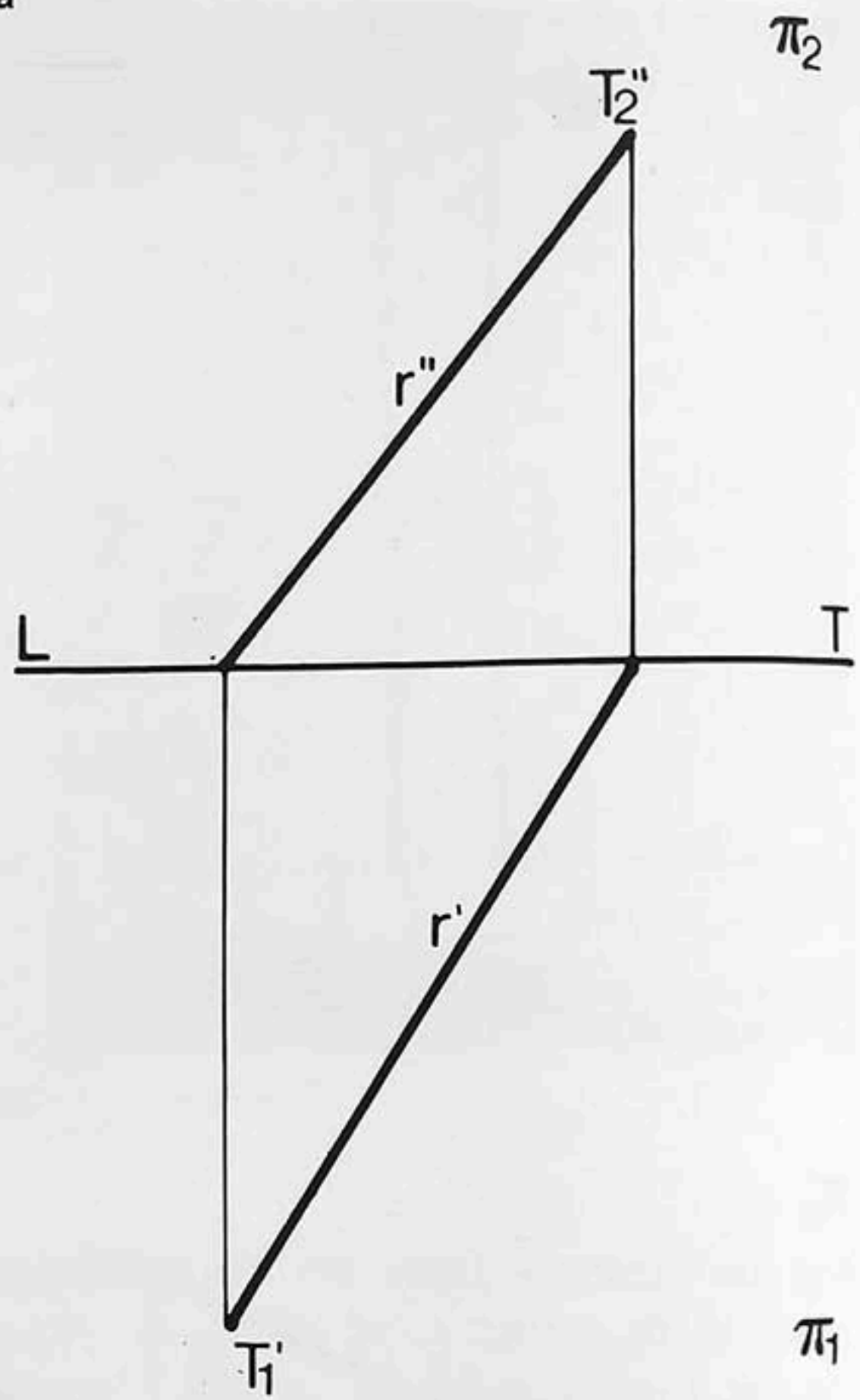
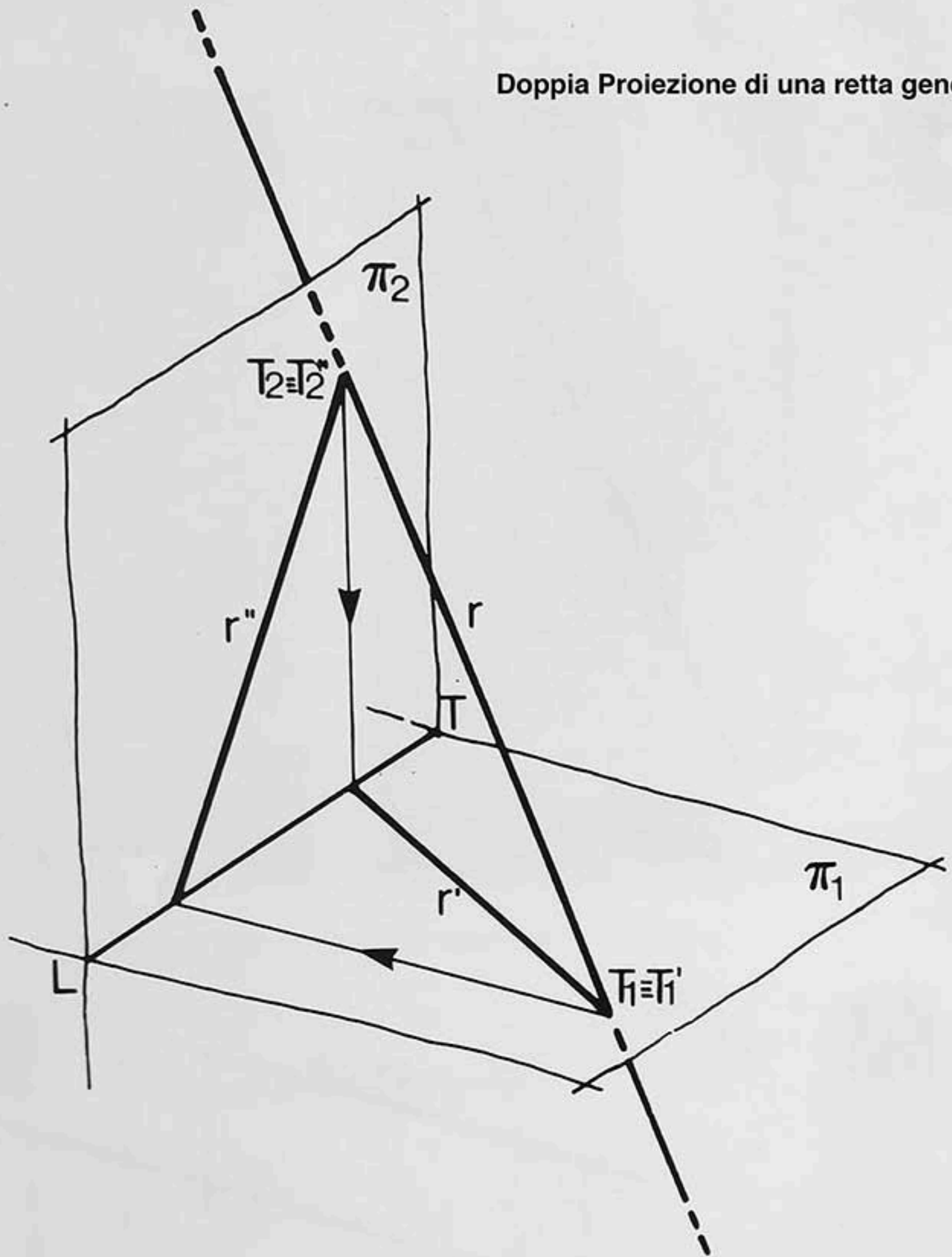

PV

$A'' \equiv B''$

LT

B'

PO

A'

Segmento parallelo al P.O. e perpendicolare al P.V.

Piano generico

1

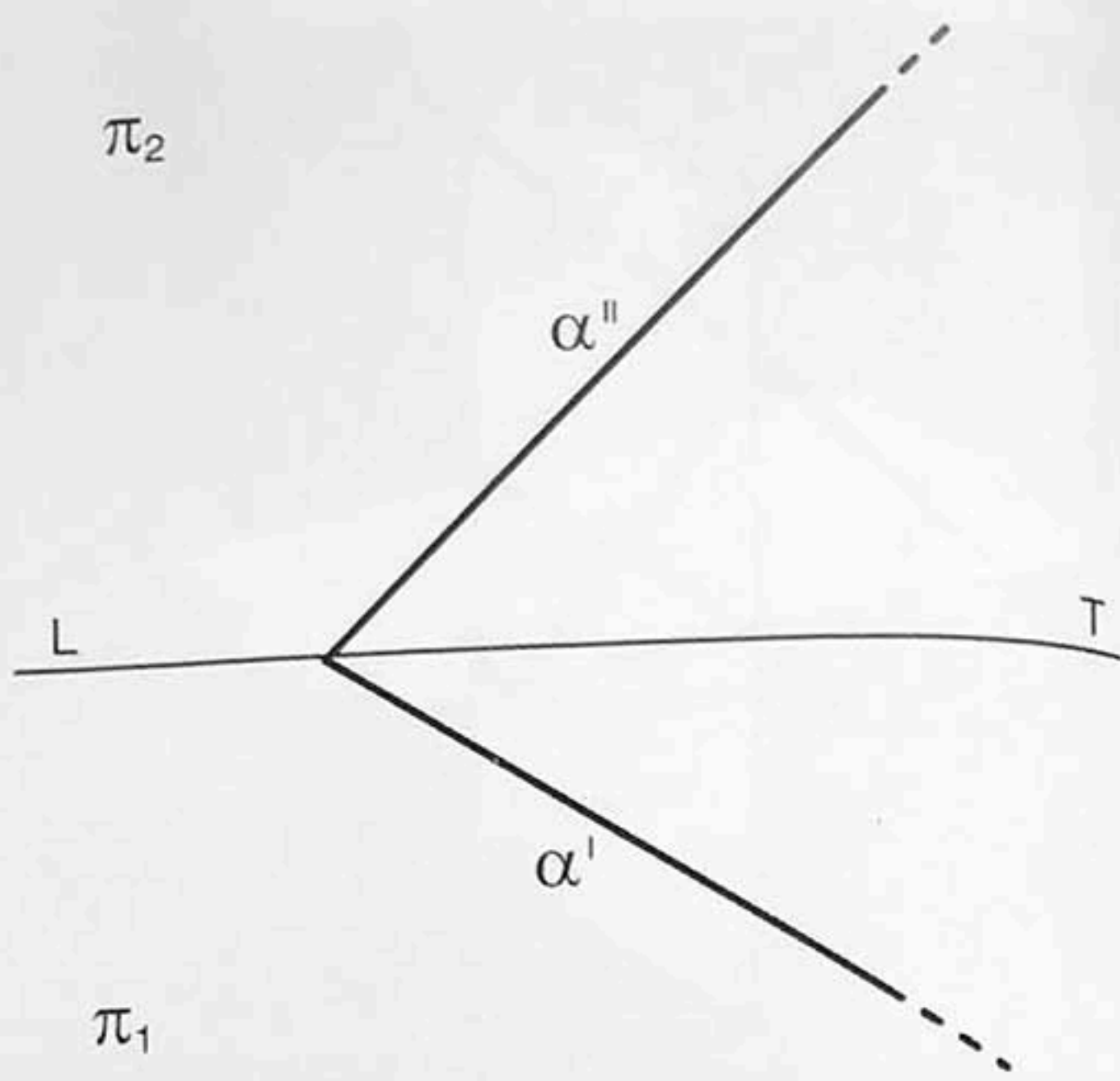
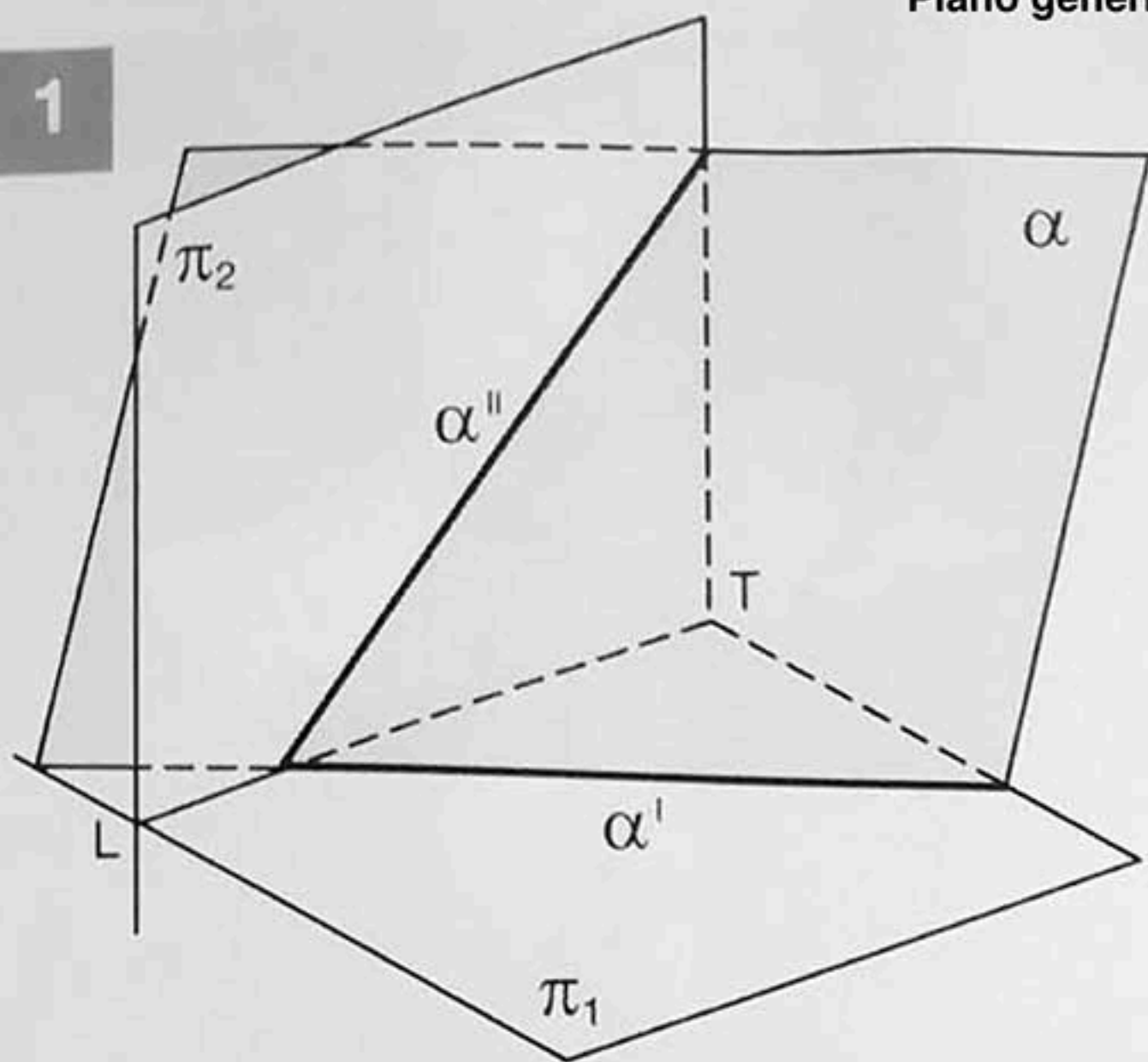

2

Piano proiettante in prima

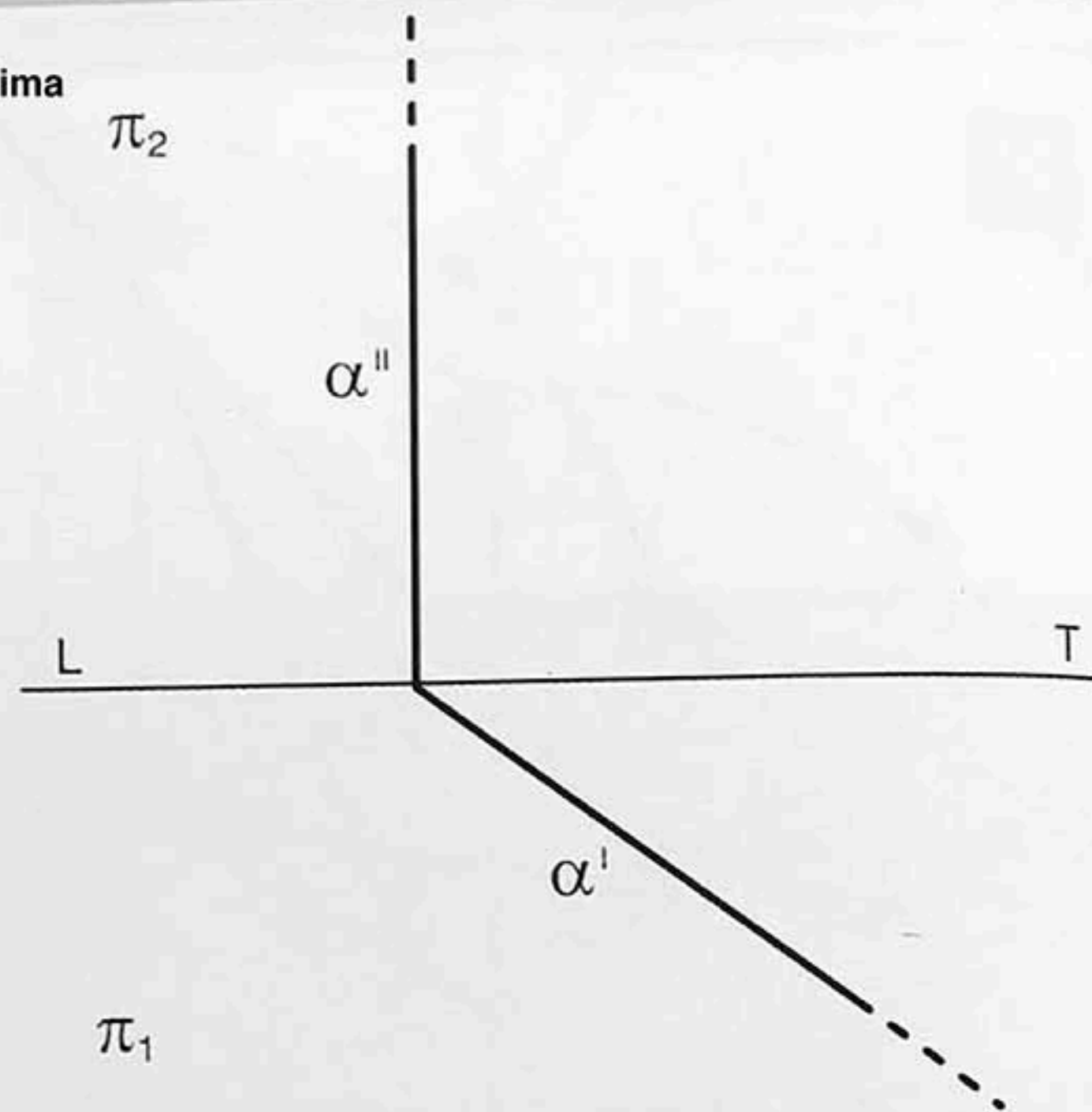
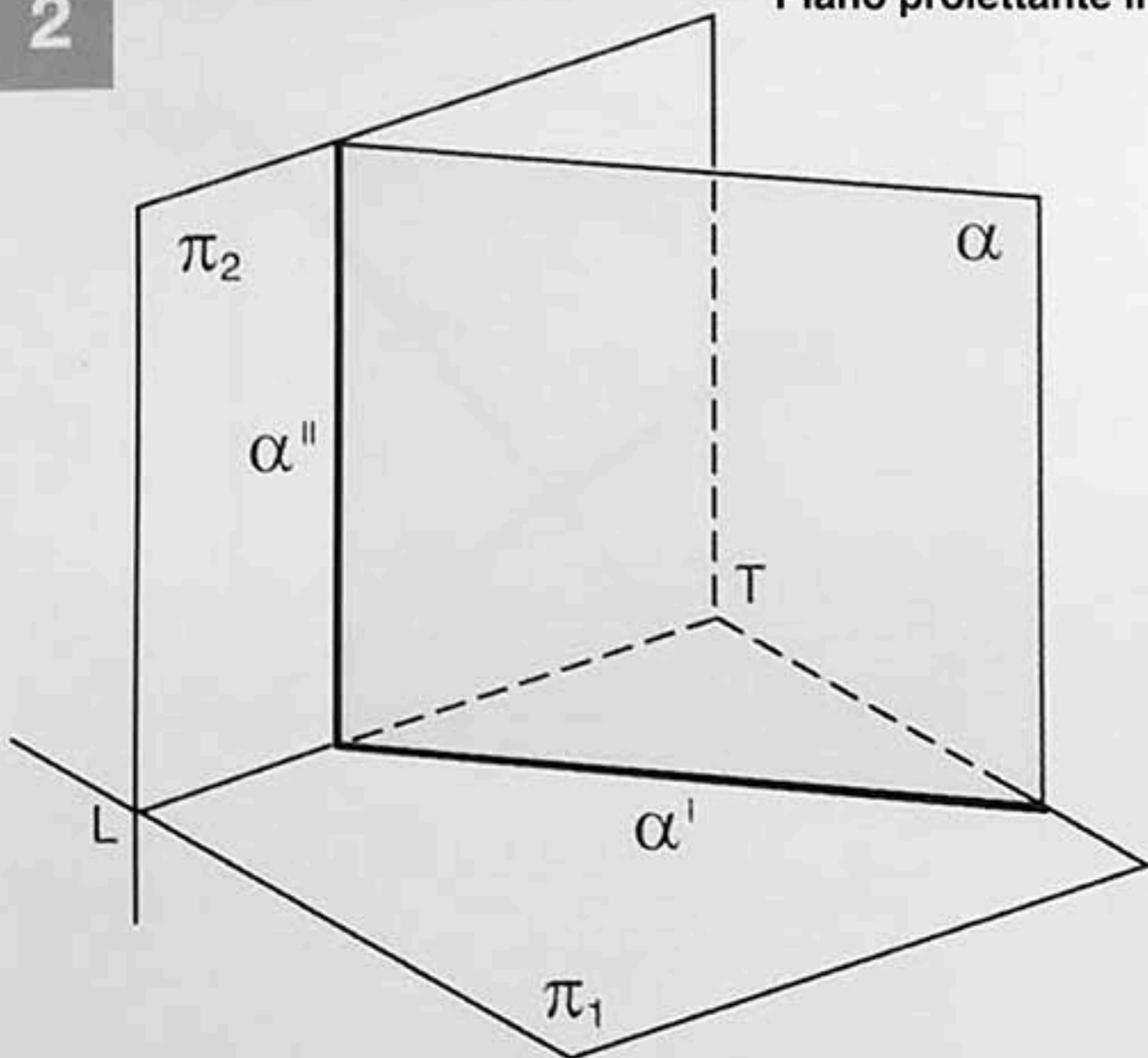

3

Piano proiettante in seconda

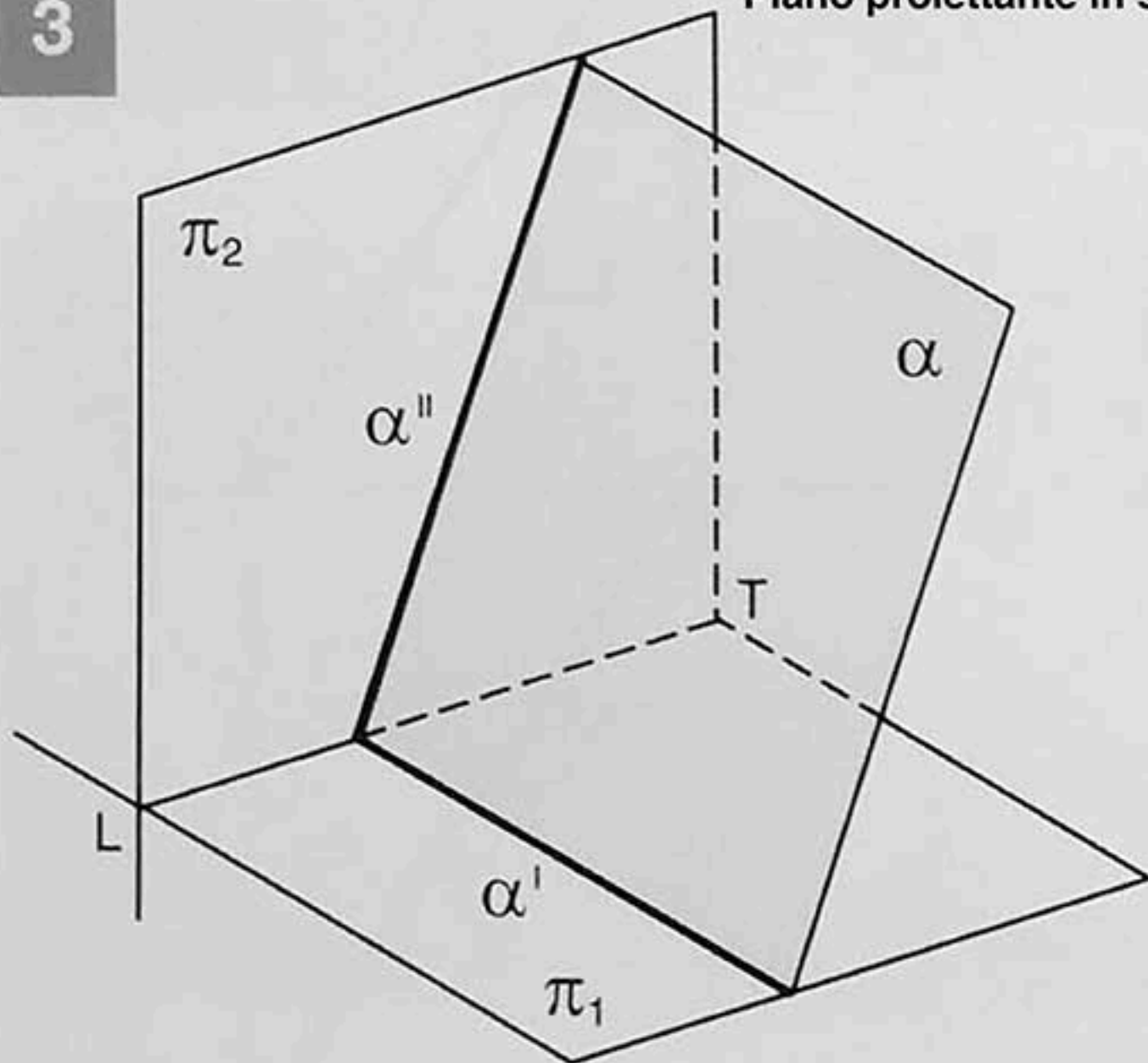
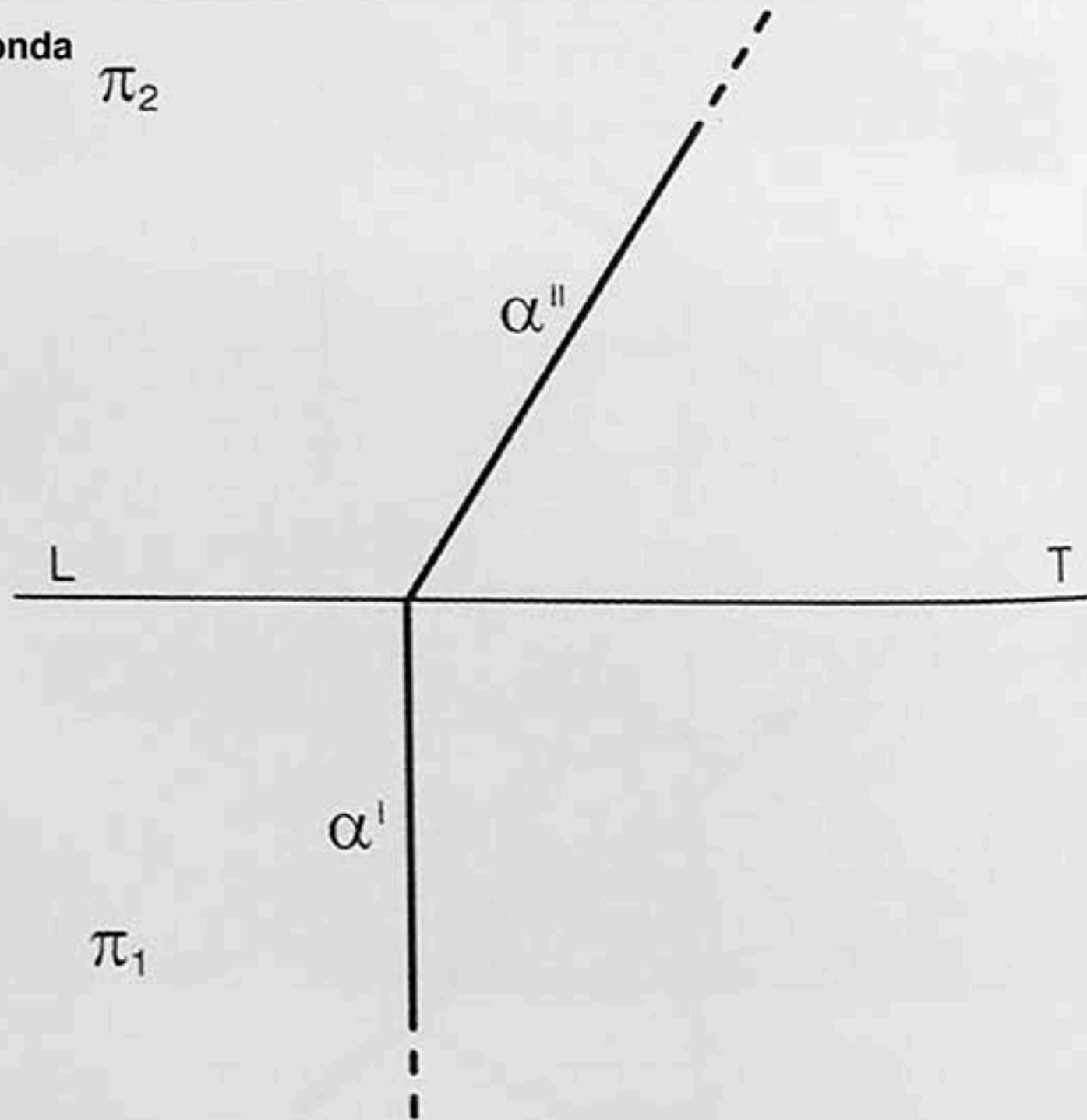
 π_2 

L

T

 α' π_1

4

Piano parallelo a LT

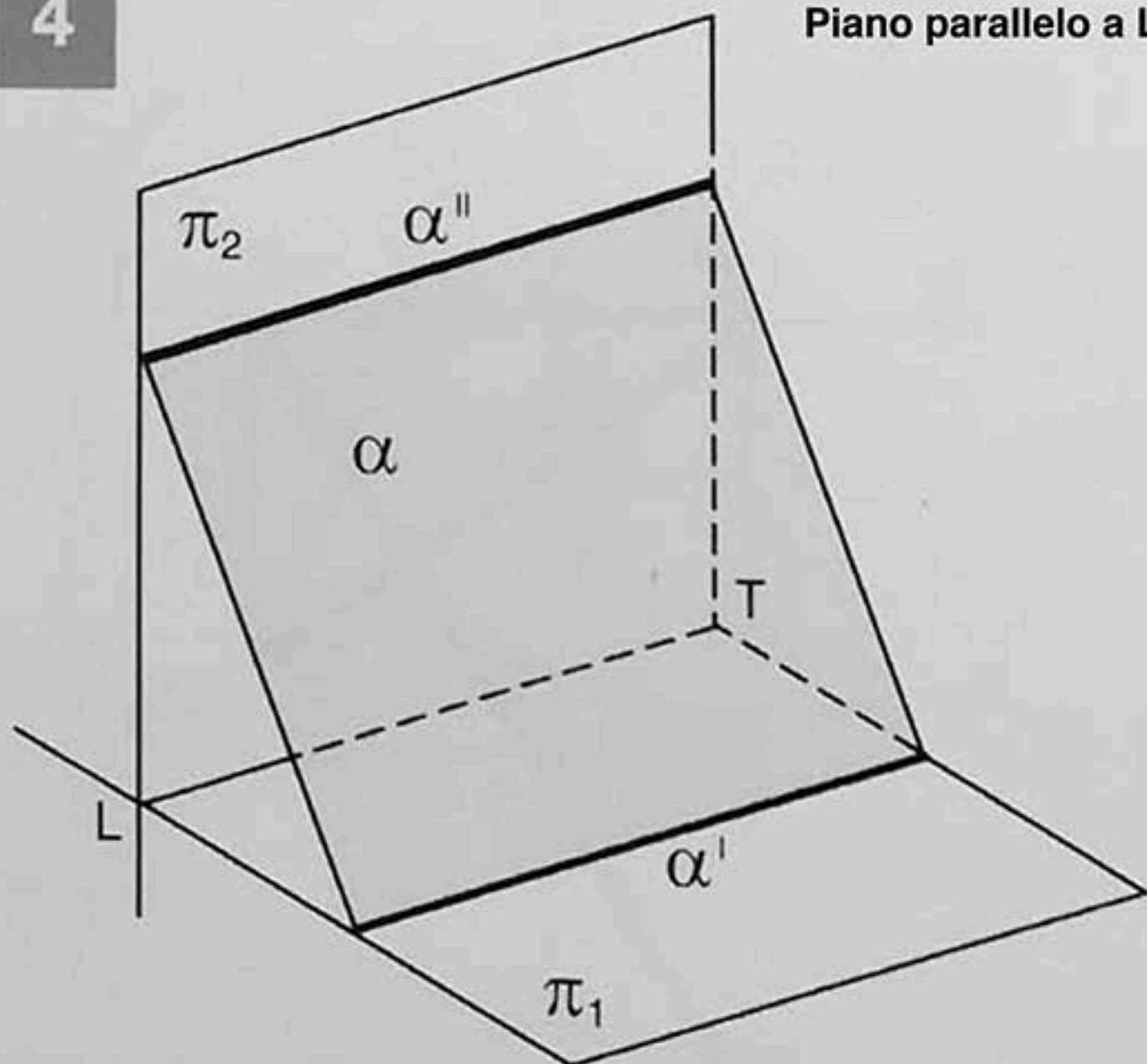
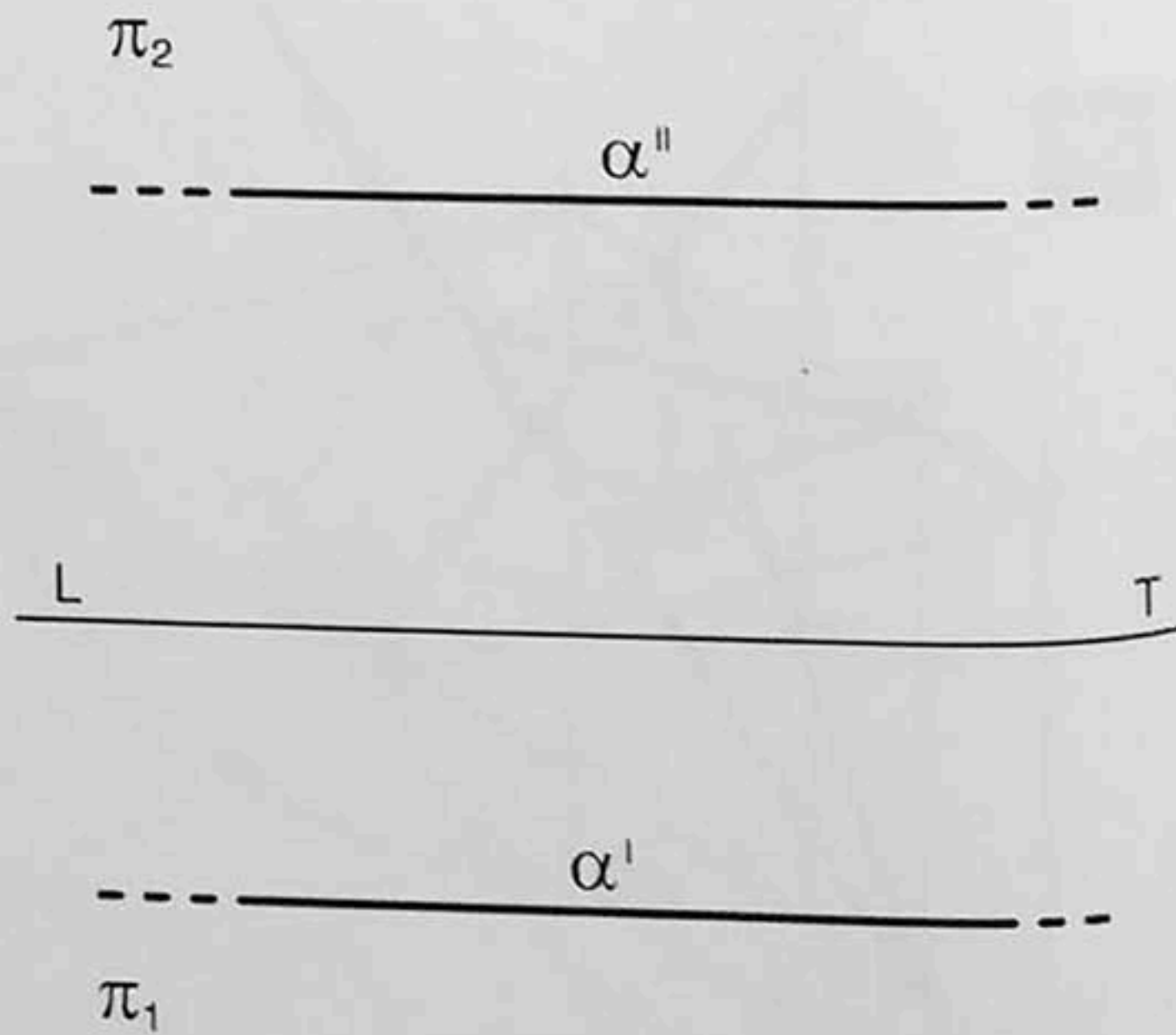
 π_2 

L

T

 α' π_1

5

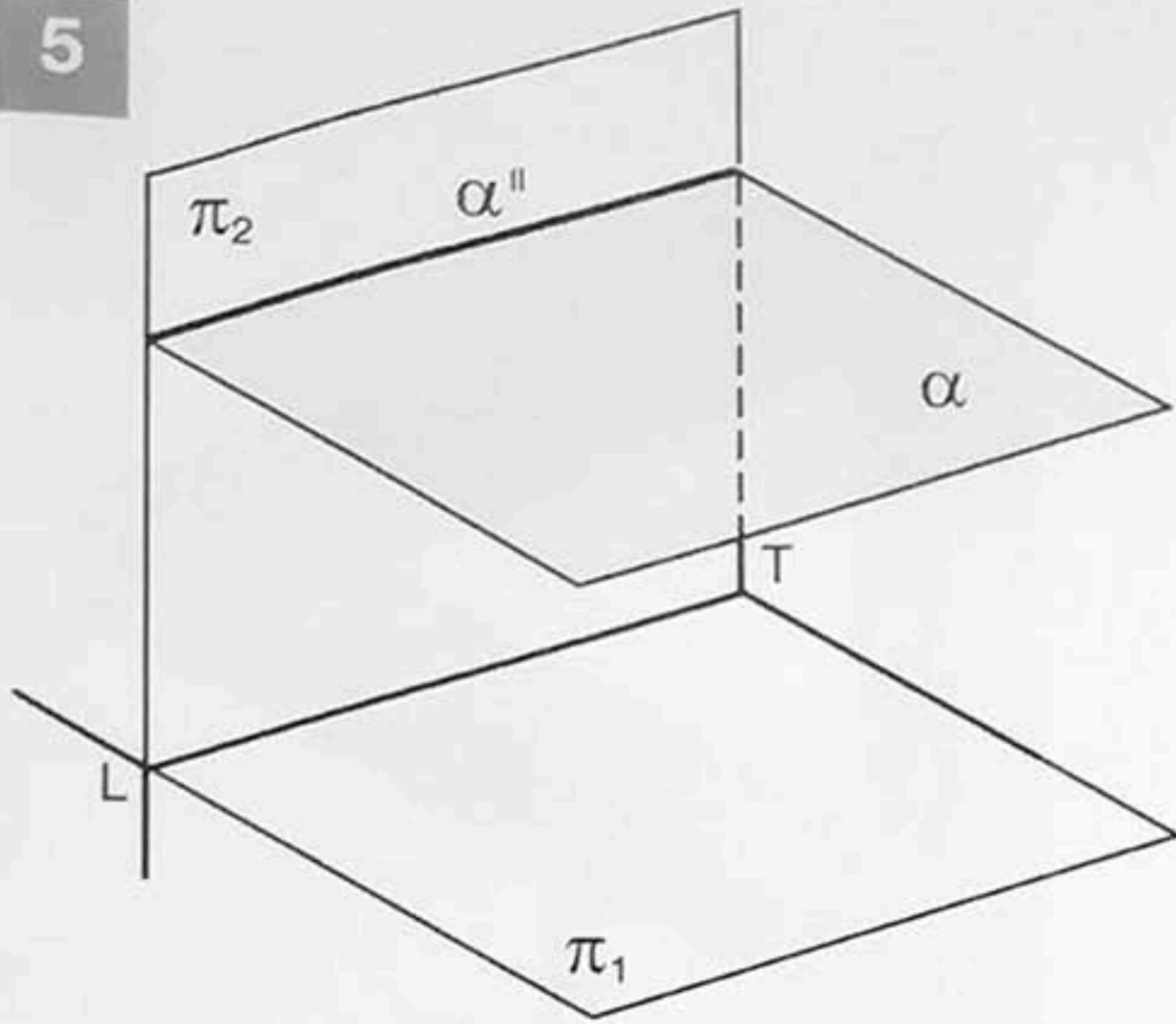
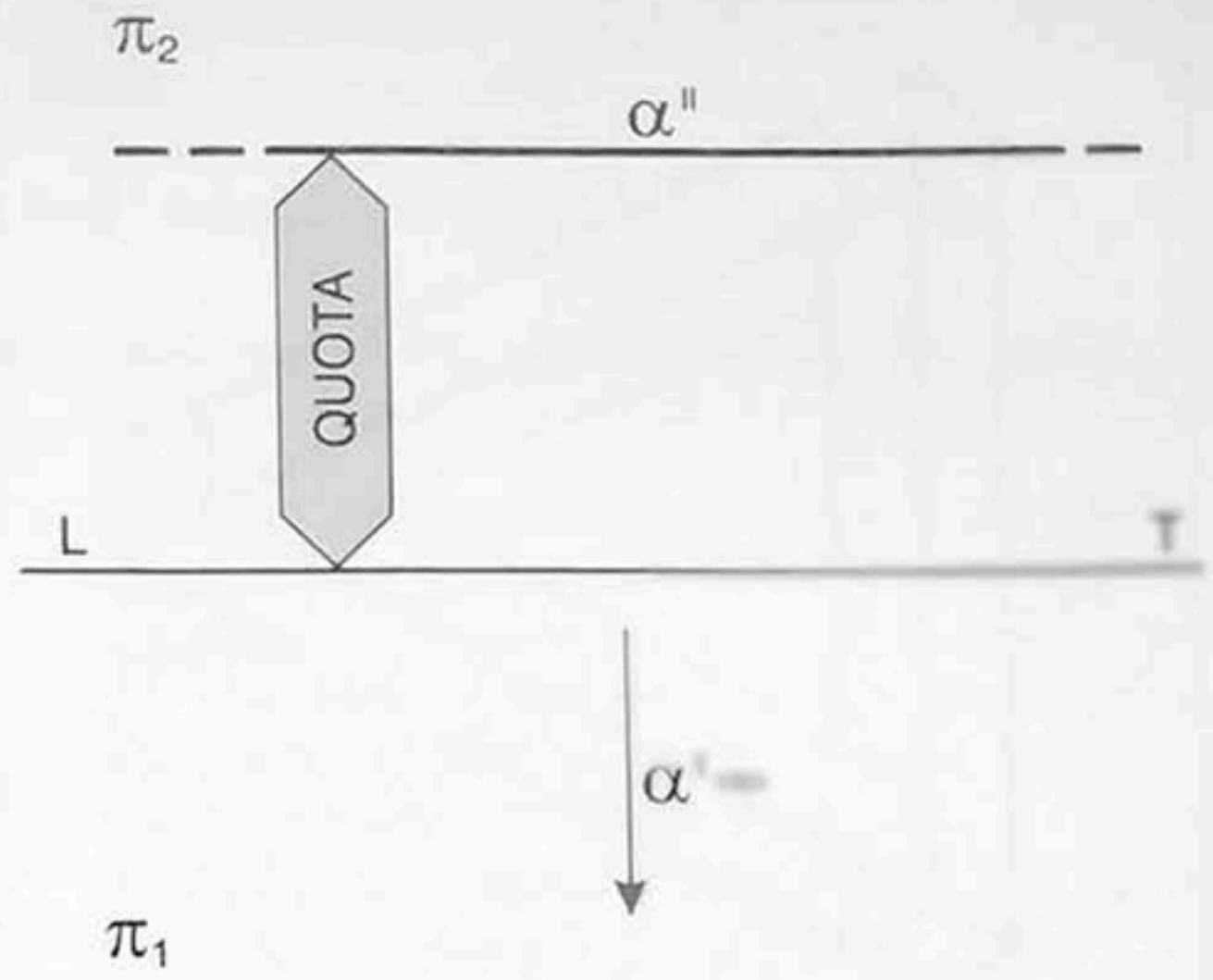
Piano proiettante π_2 e parallelo a π_1 

6

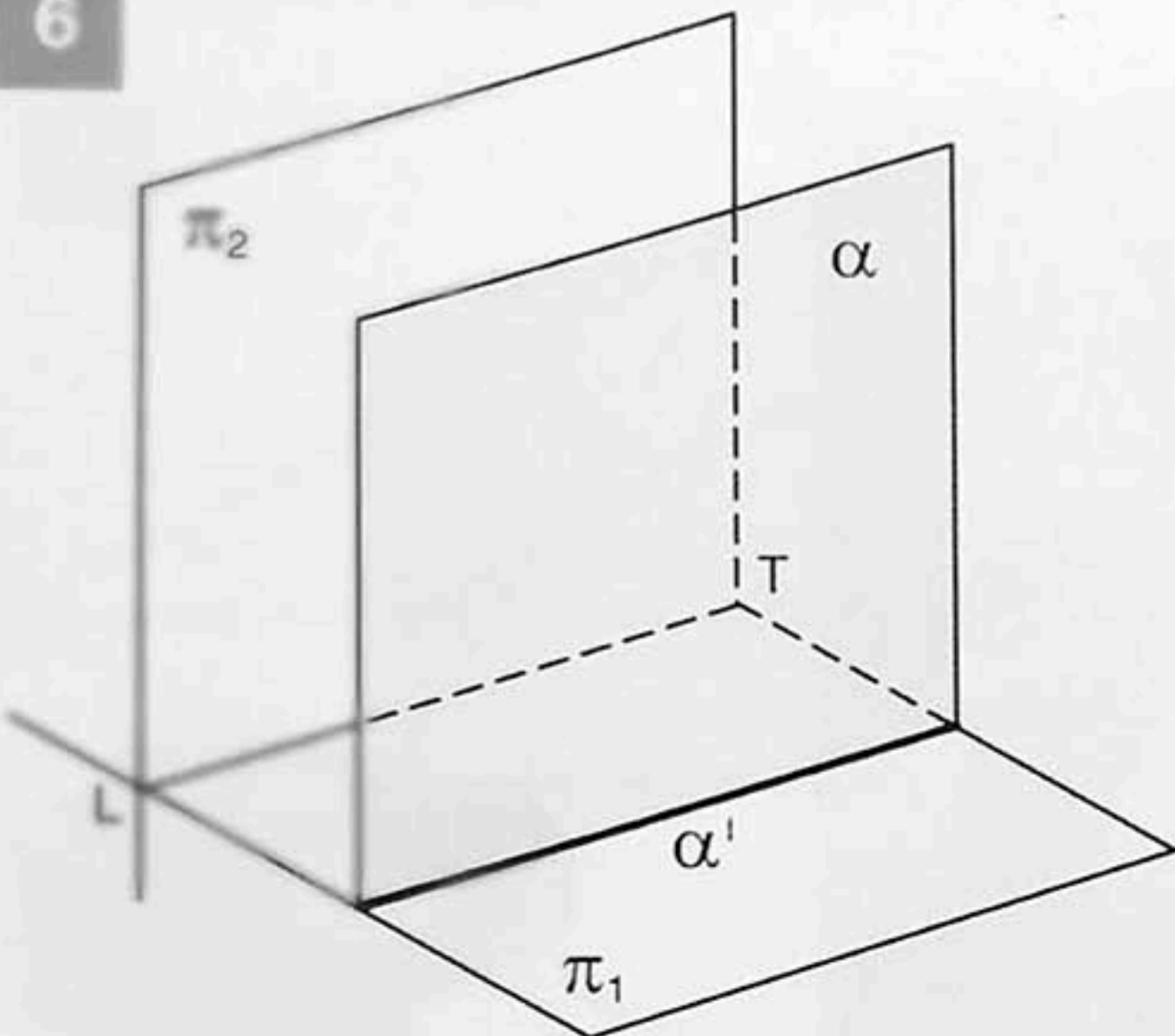
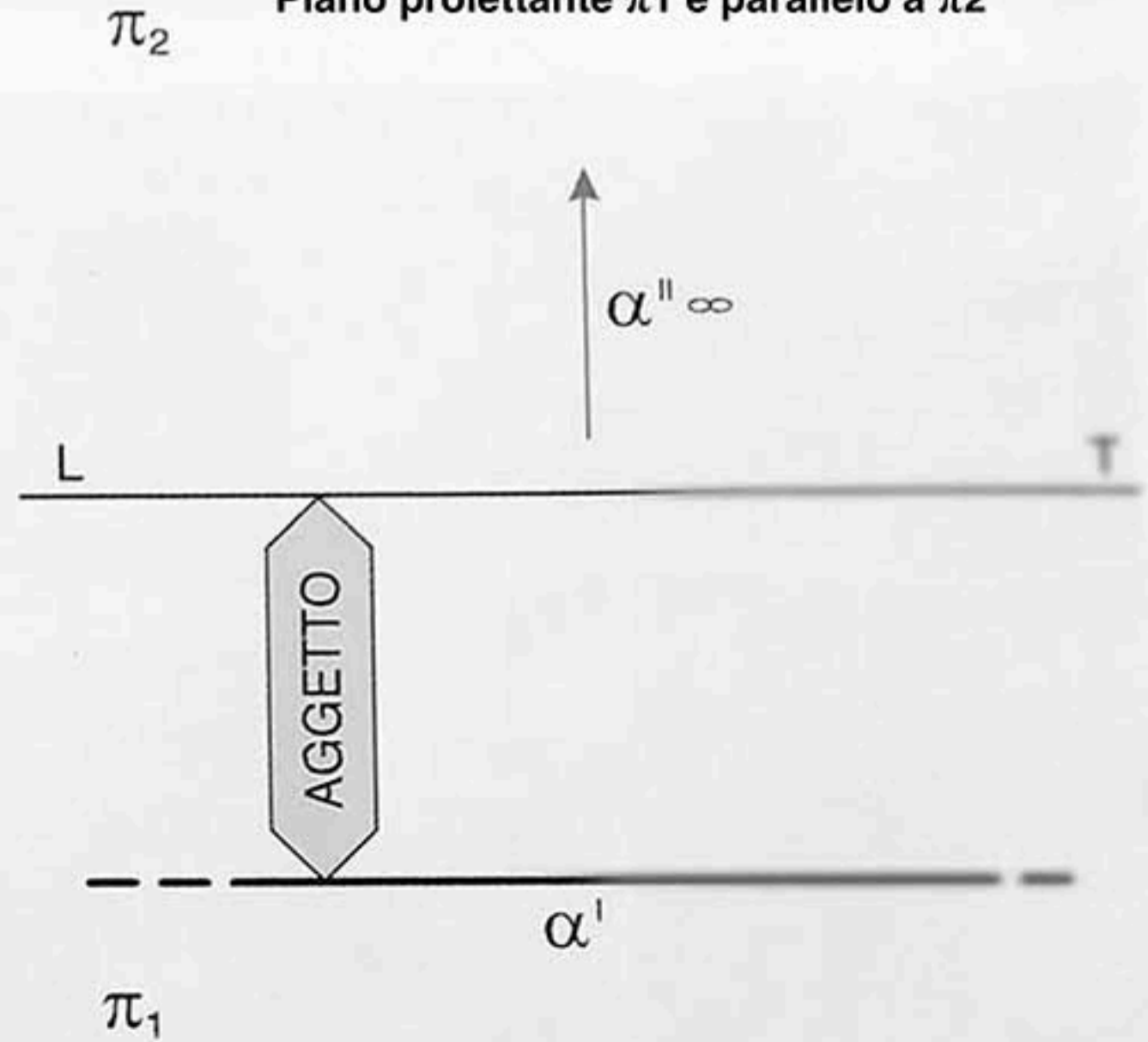
Piano proiettante π_1 e parallelo a π_2 

7

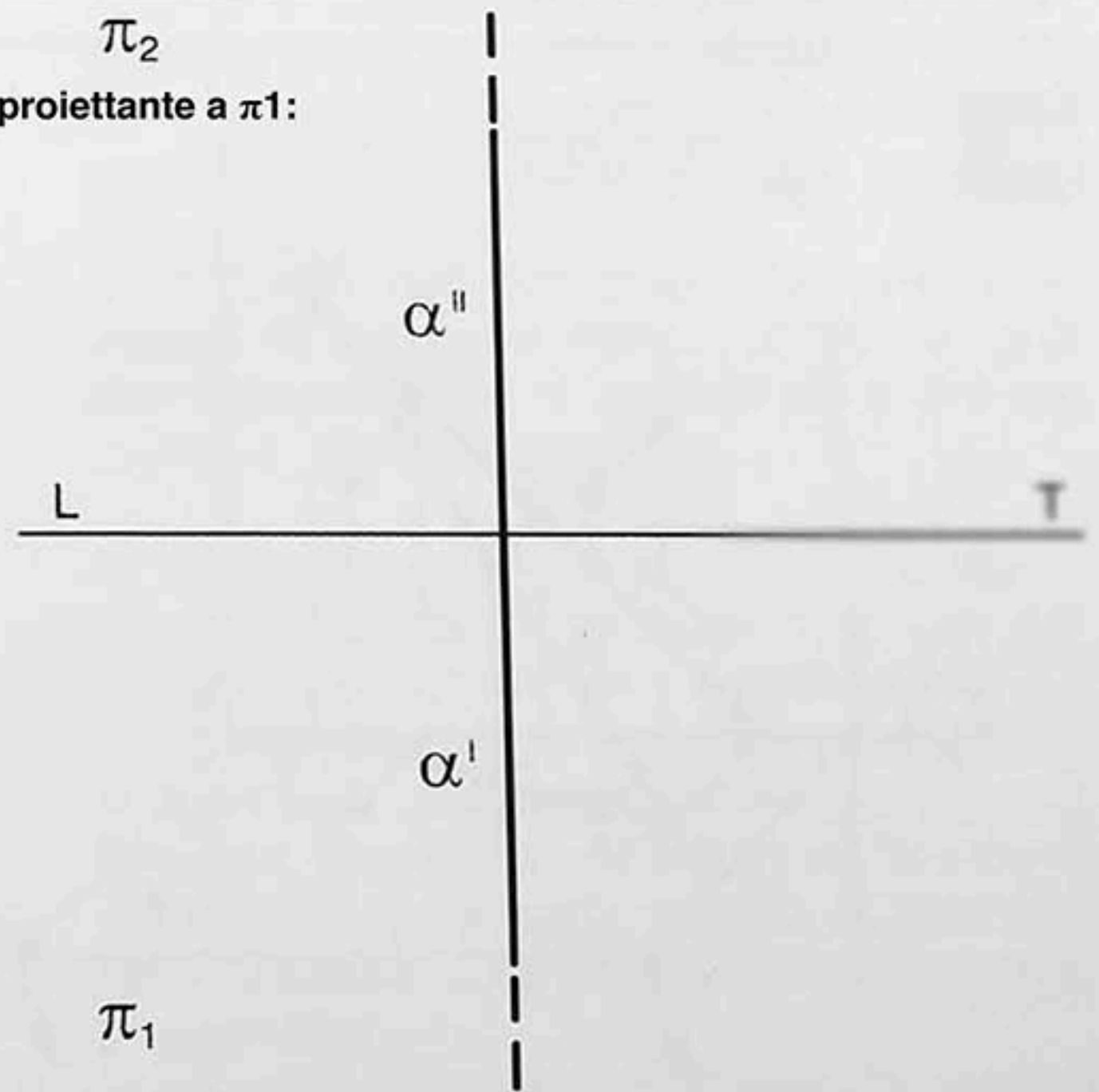
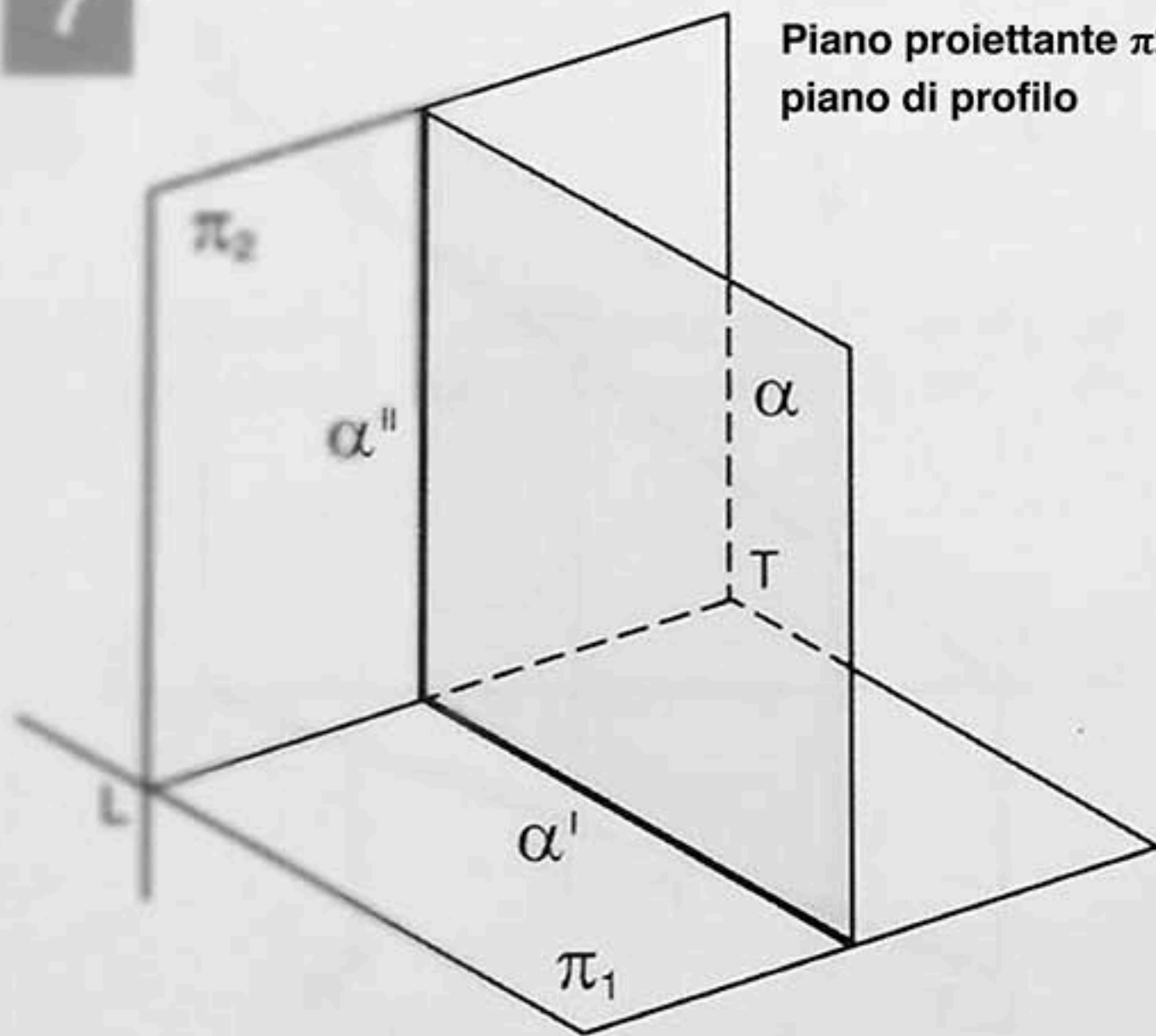

8

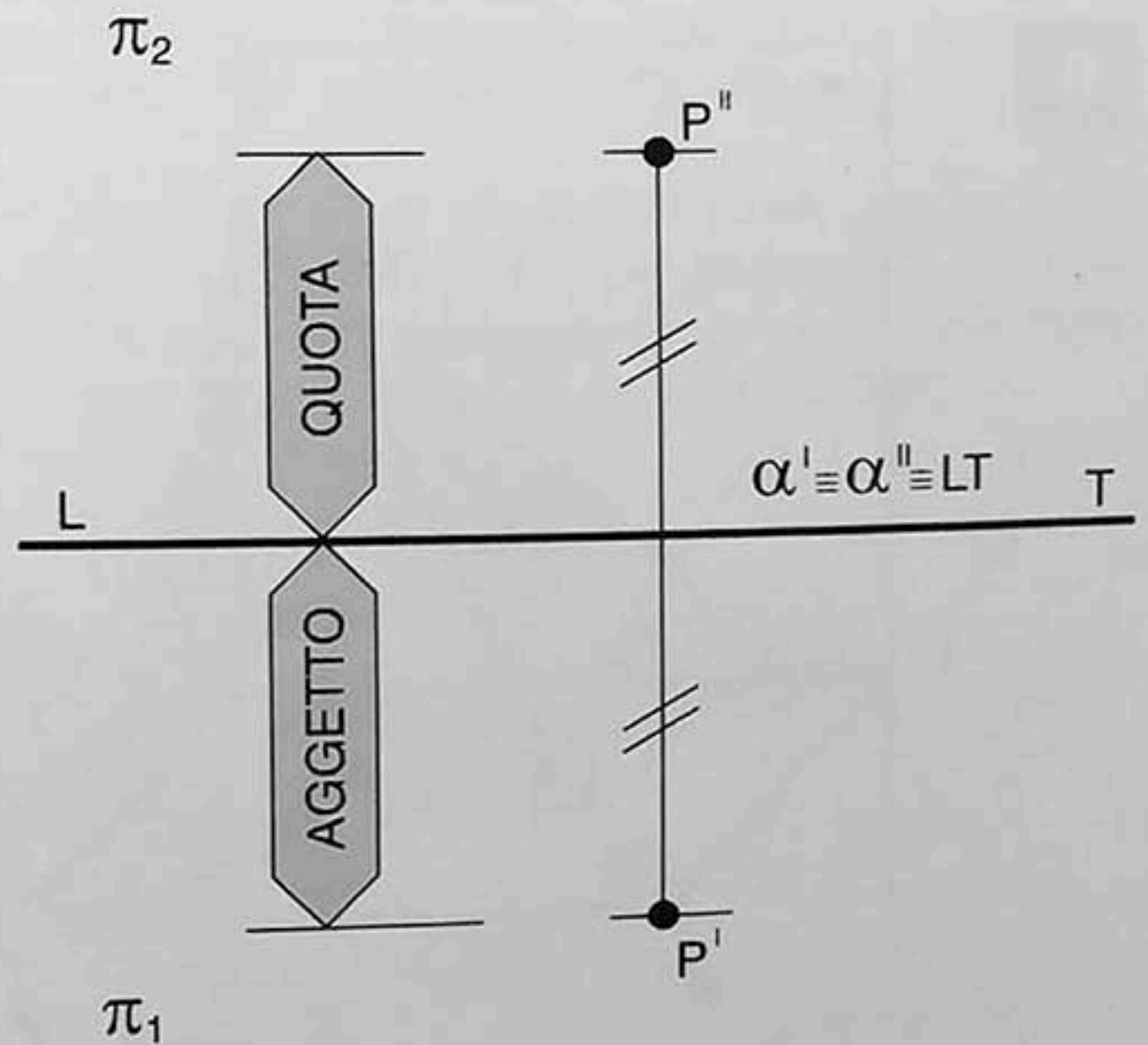
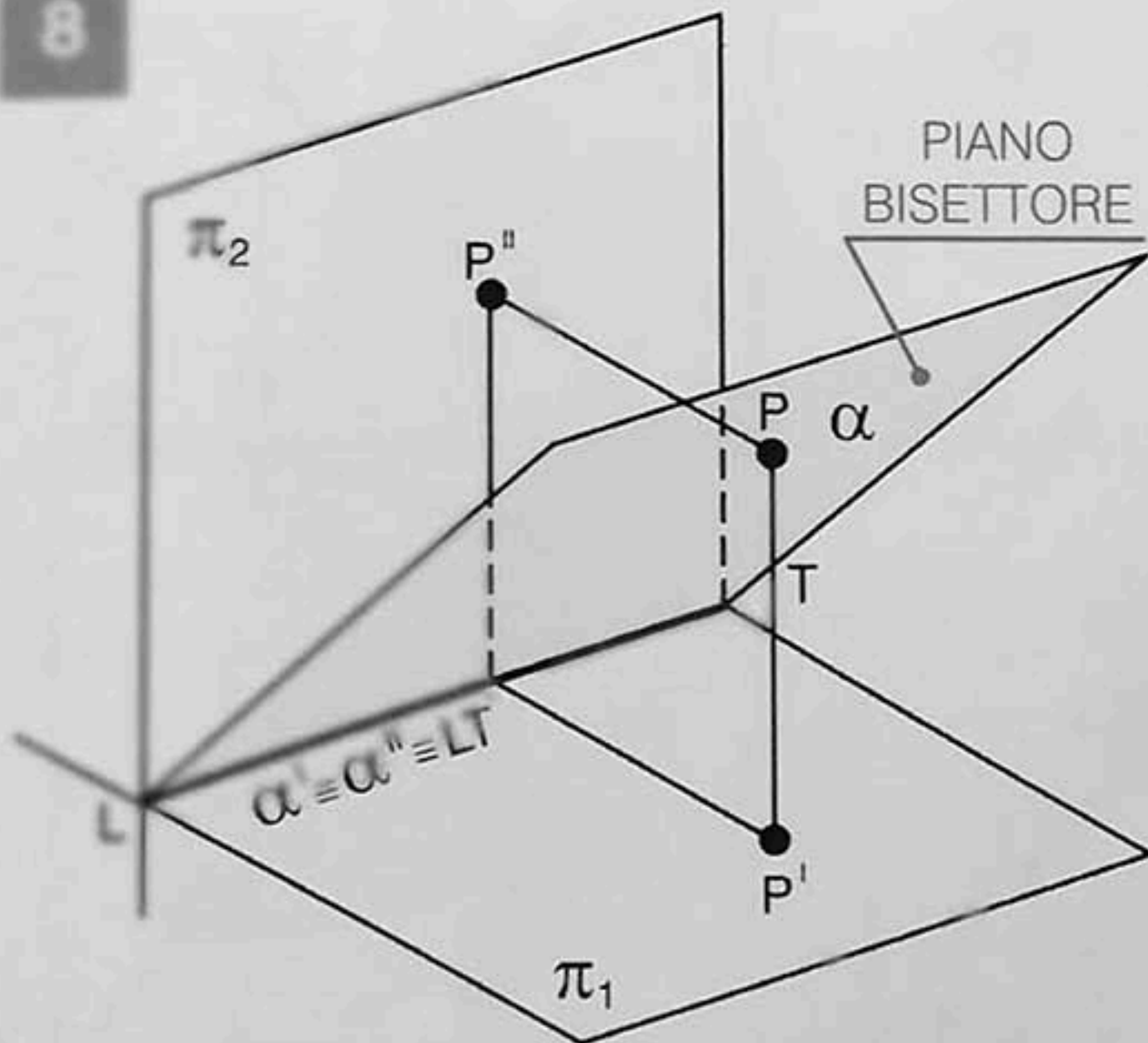

Condizione di appartenenza

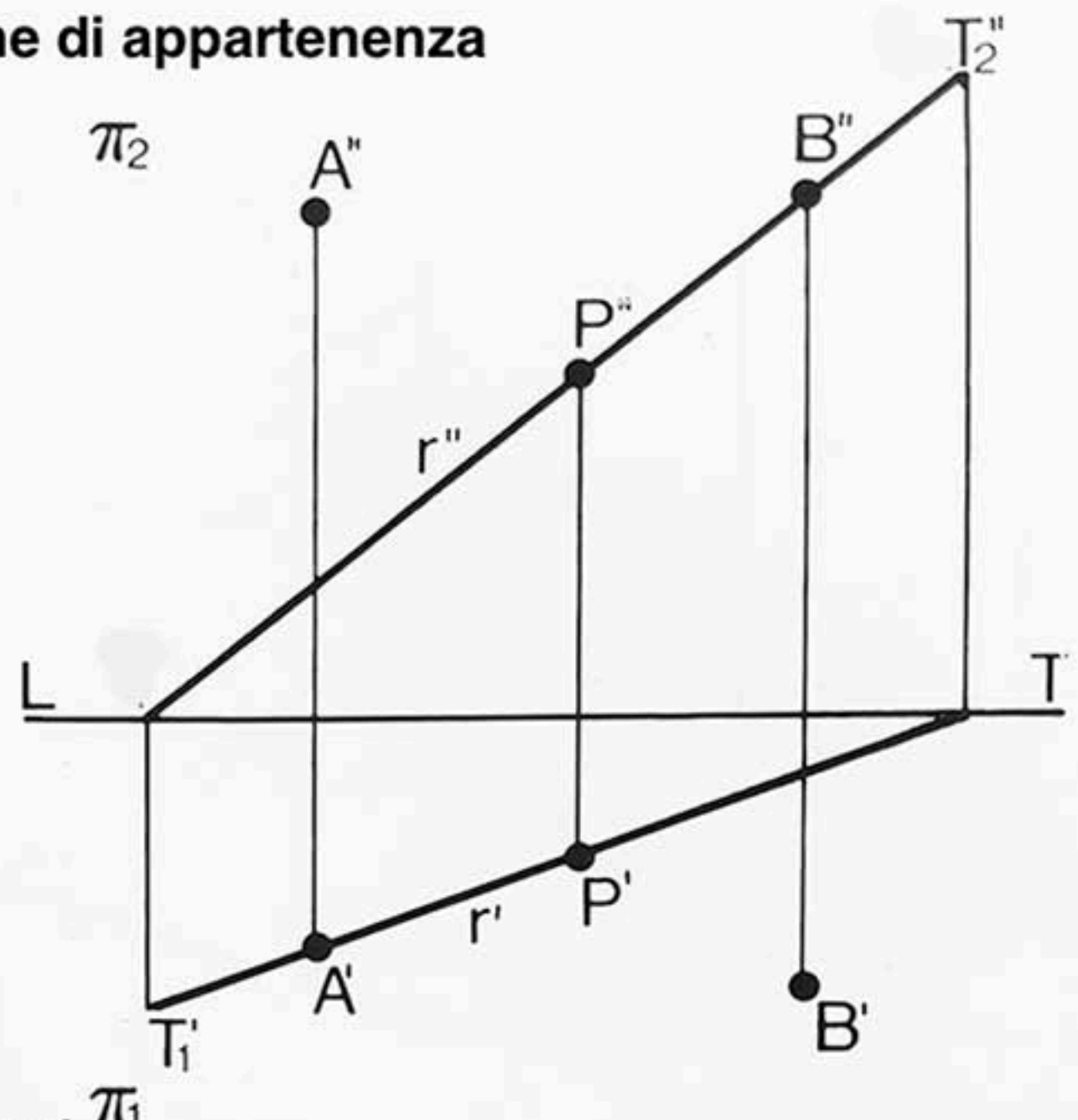
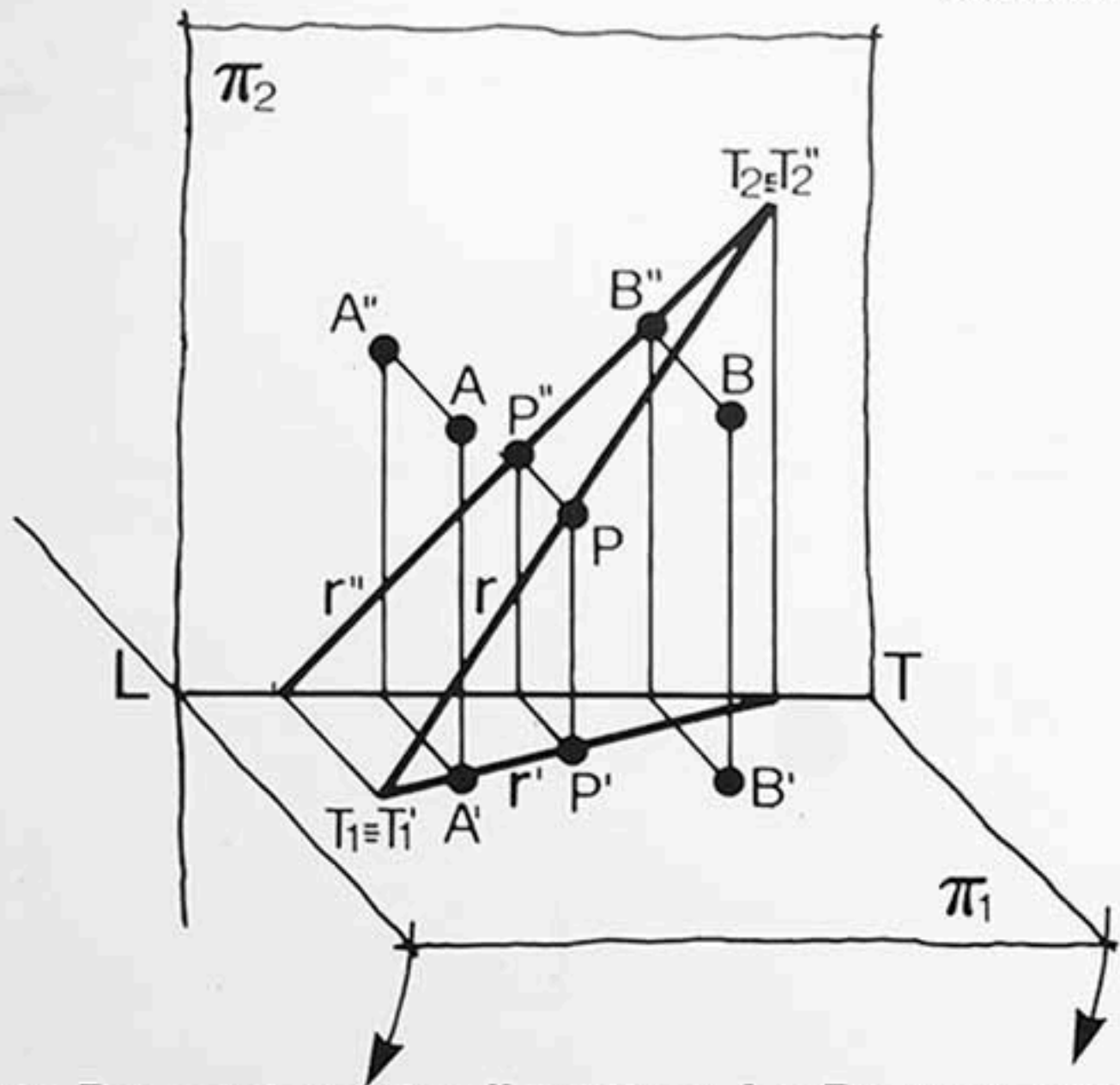

punto P appartenente alla retta r ; A e B non appartenenti

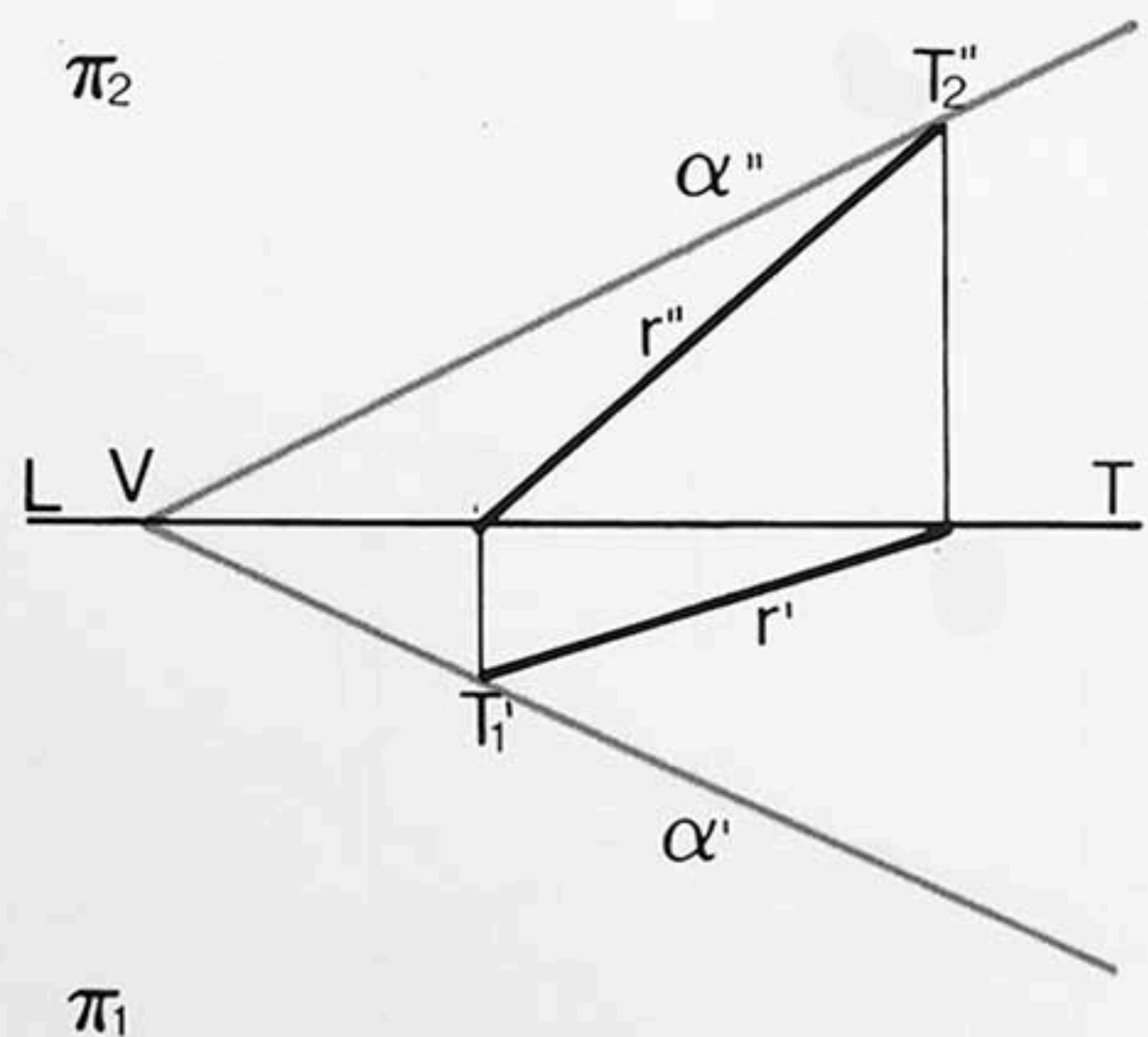
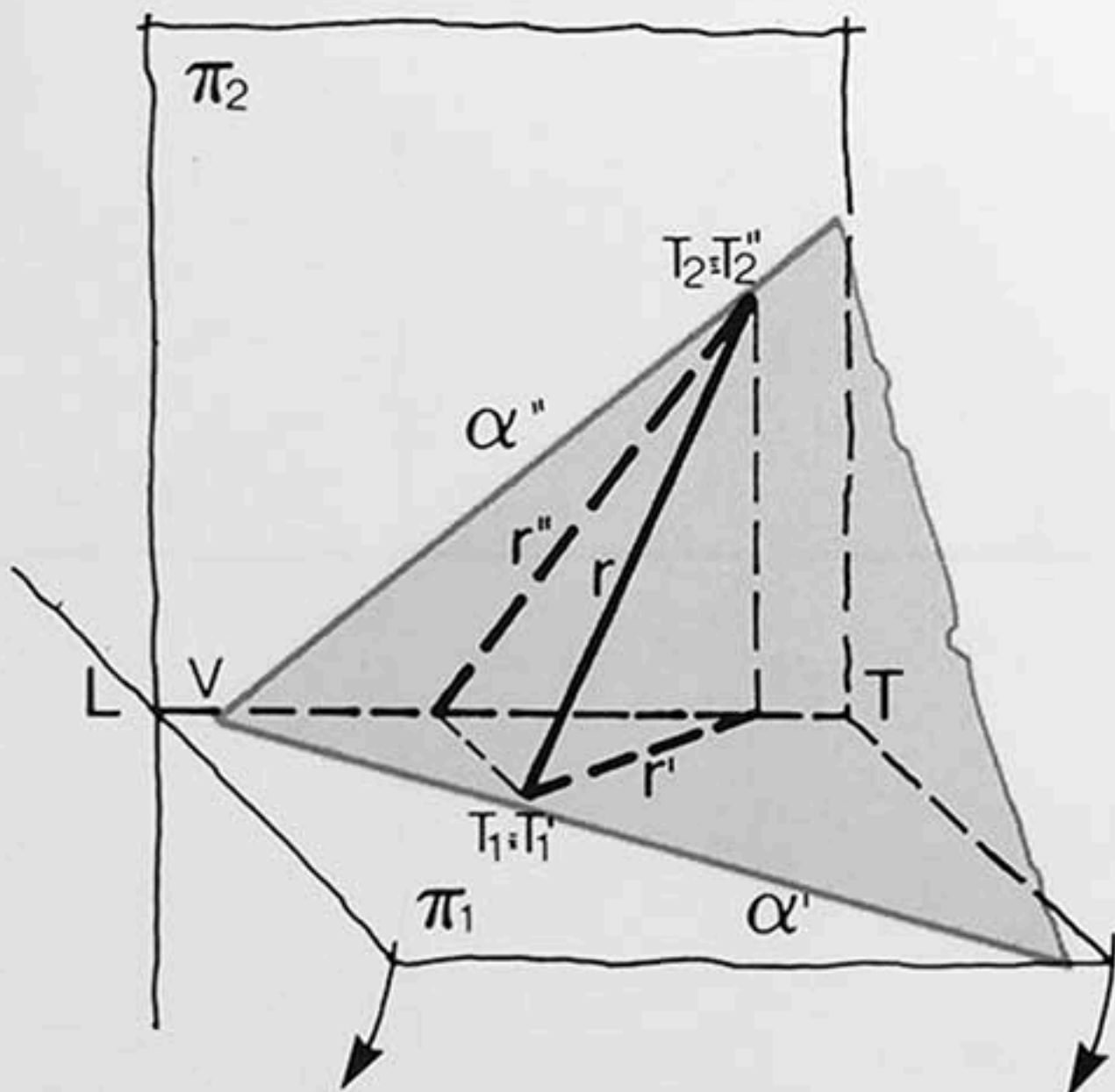

retta r appartenente al piano generico α

Retta orizzontale

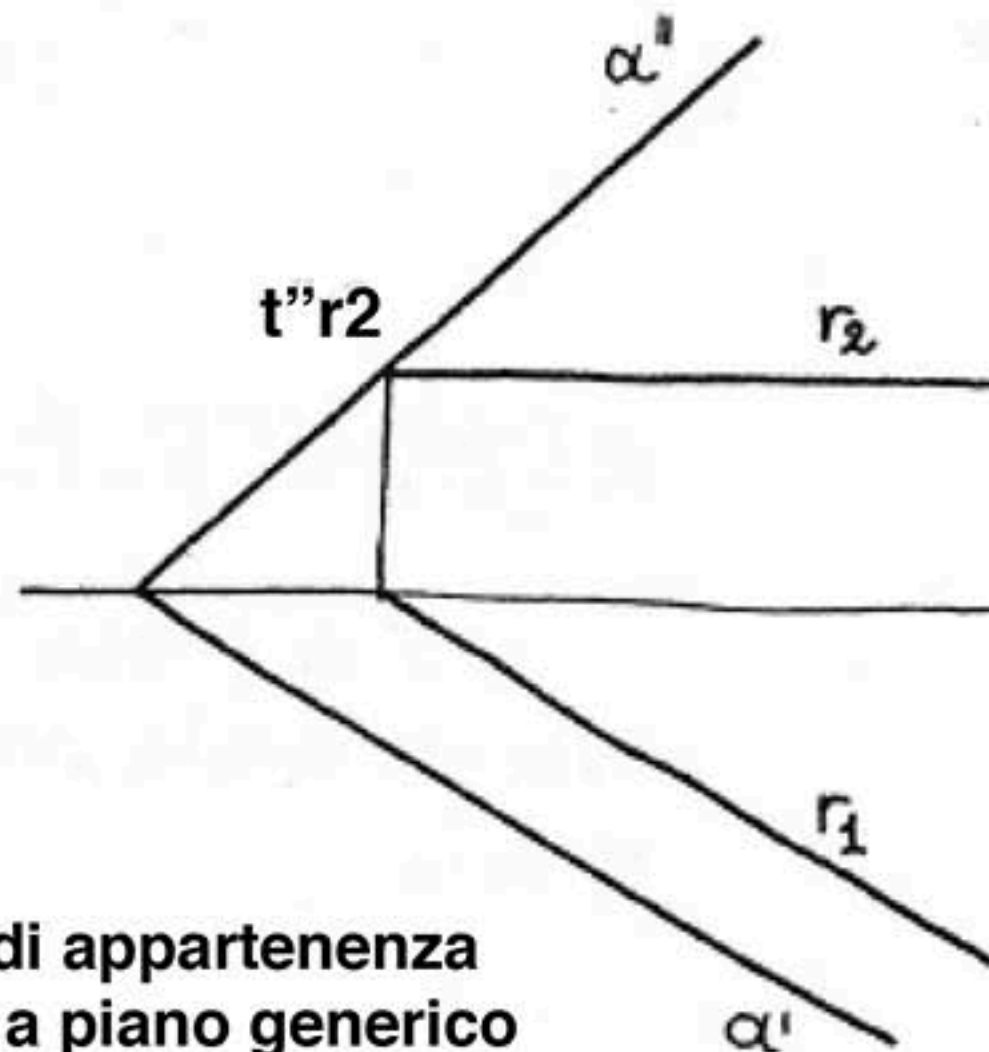
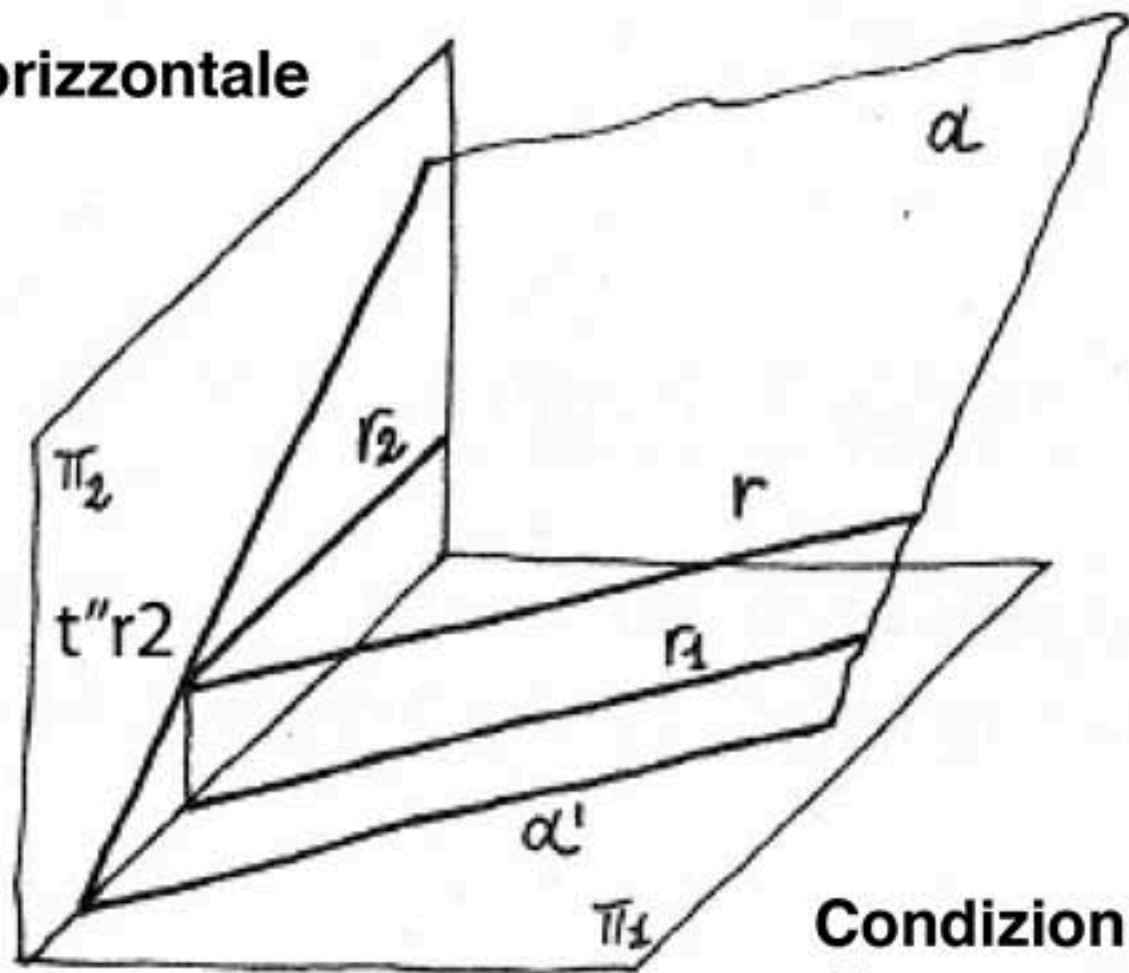

**Condizioni di appartenenza
di una retta a piano generico**

Retta frontale

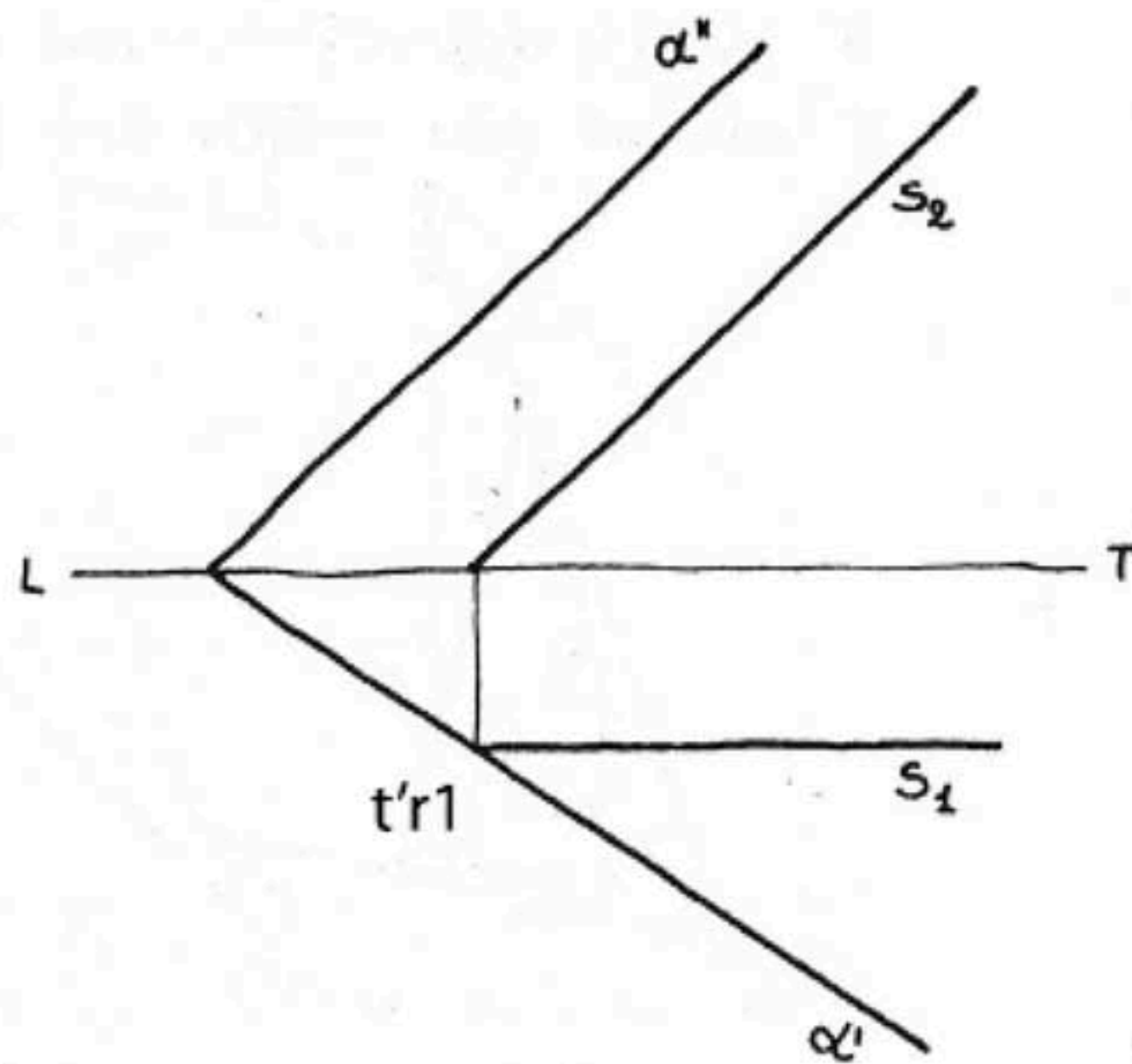
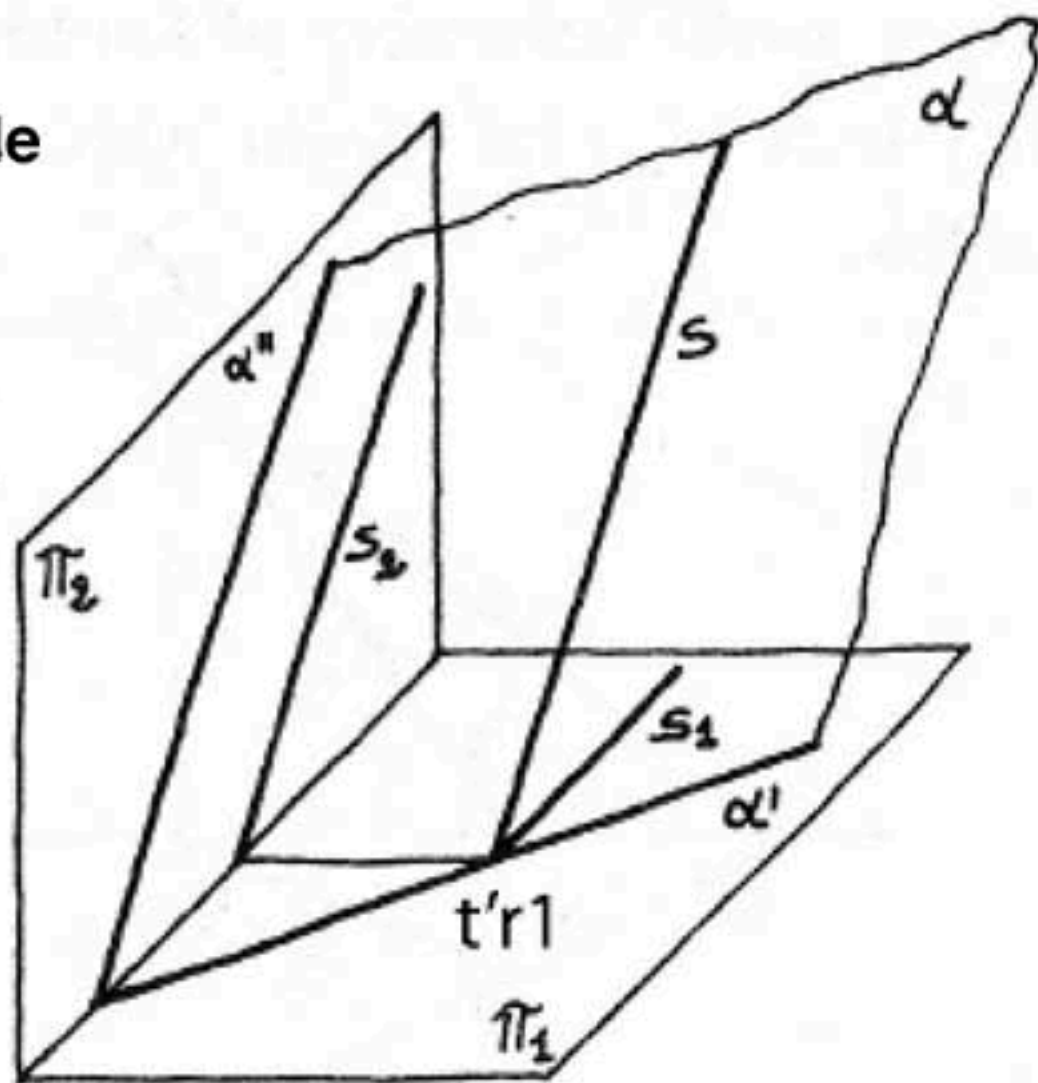

Intersezione tra due piani generici

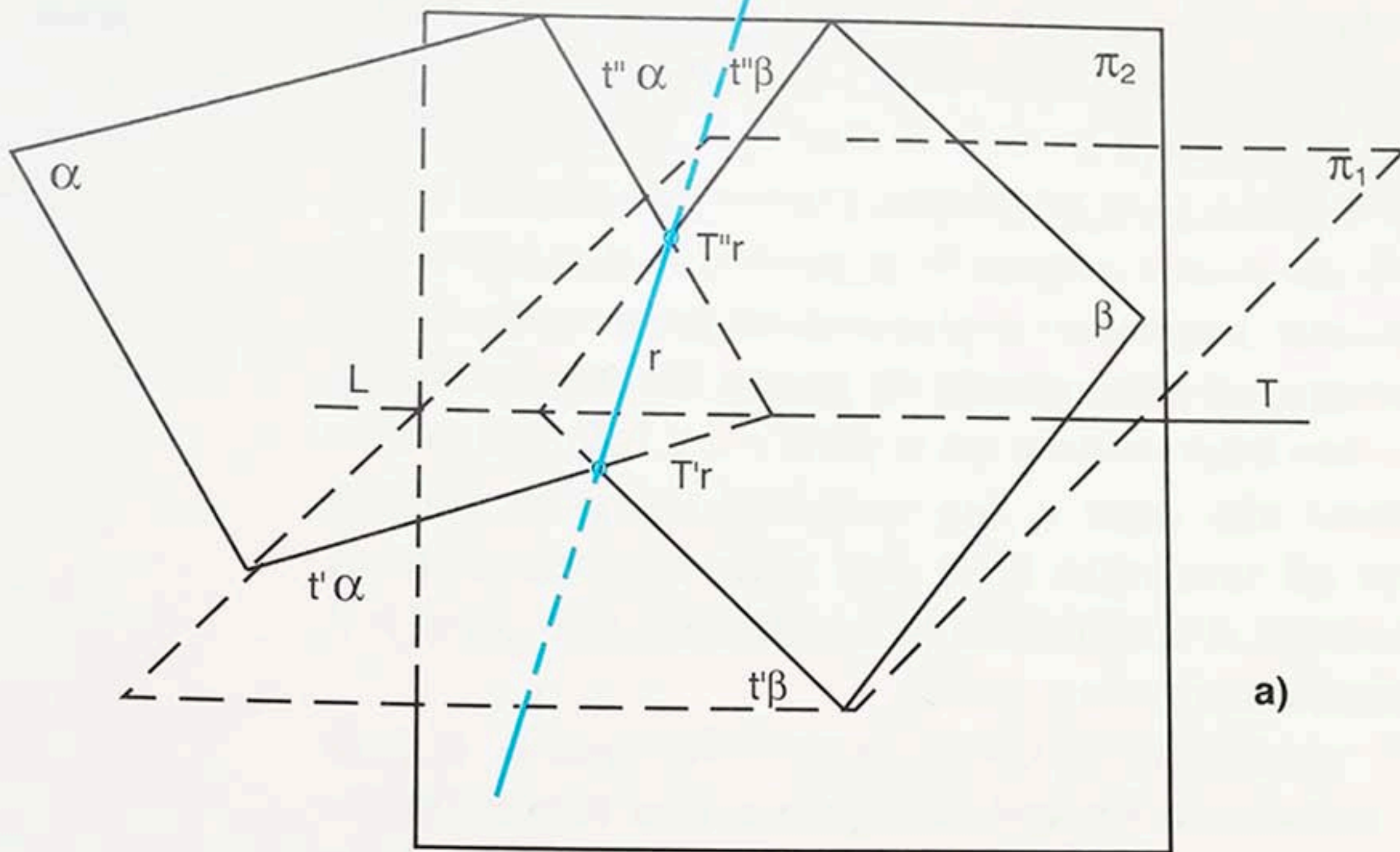

a)

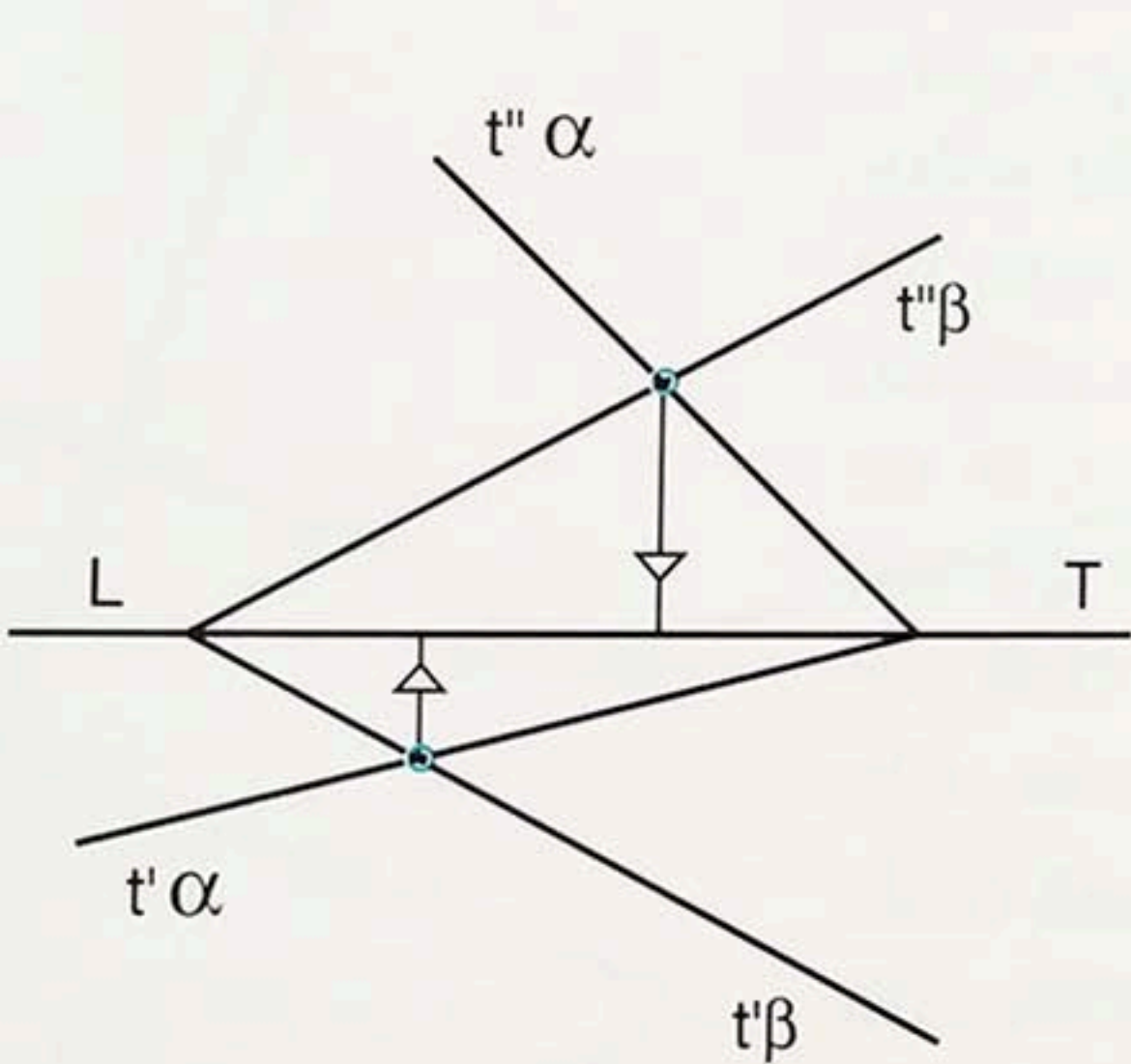

b)

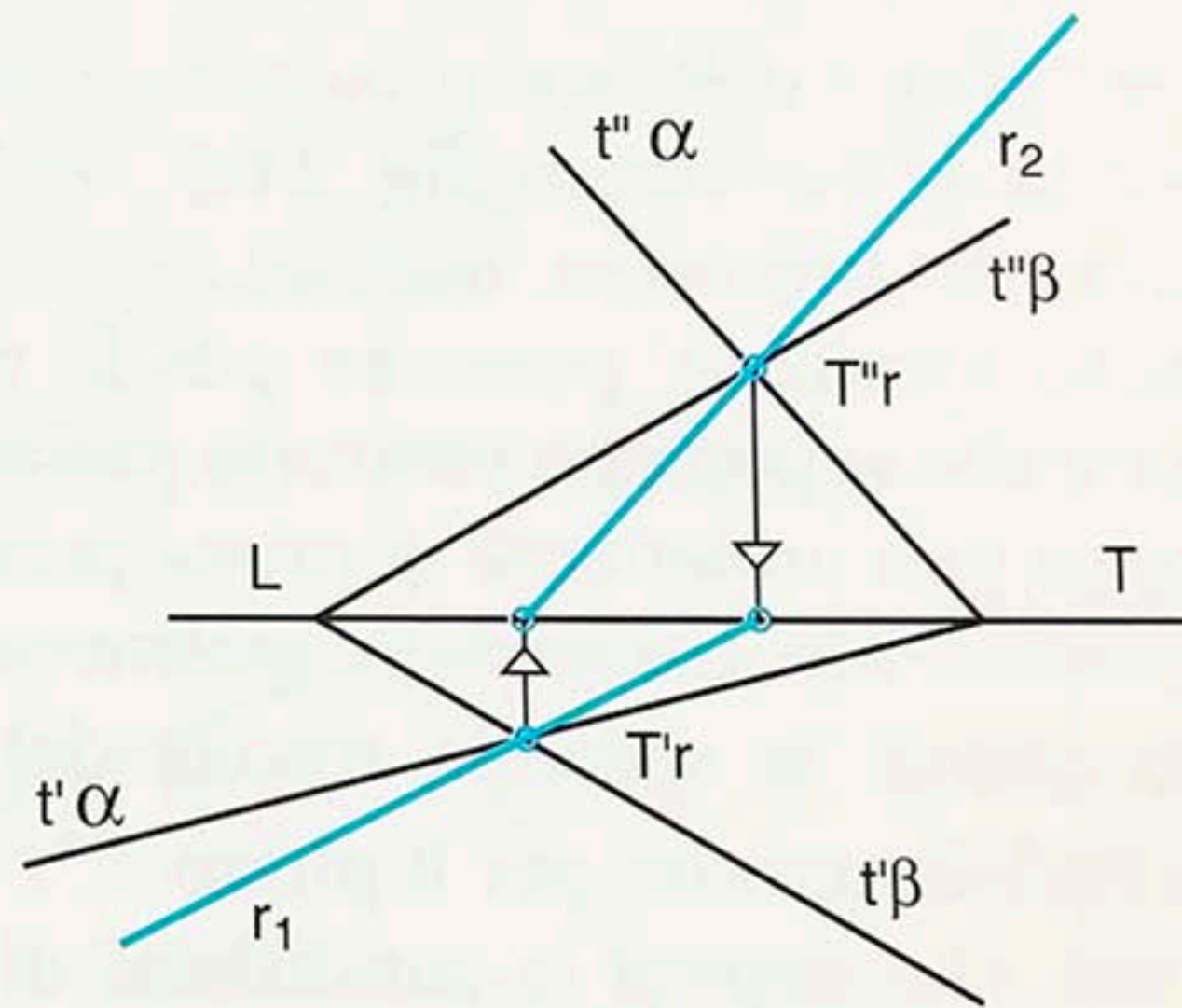

c)

Intersezione di due rette

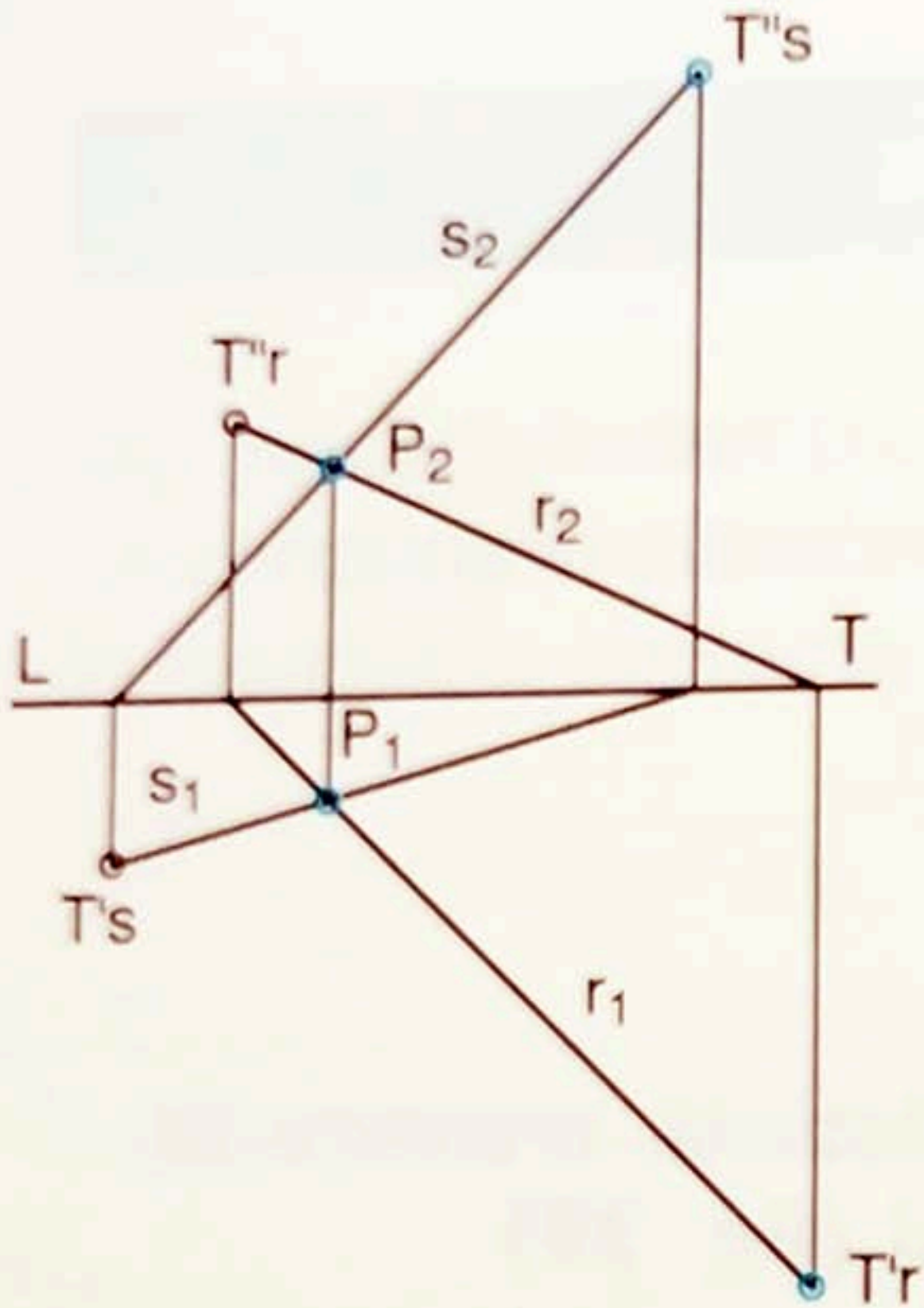

a)

Appartenenza di due rette incidenti a un piano generico

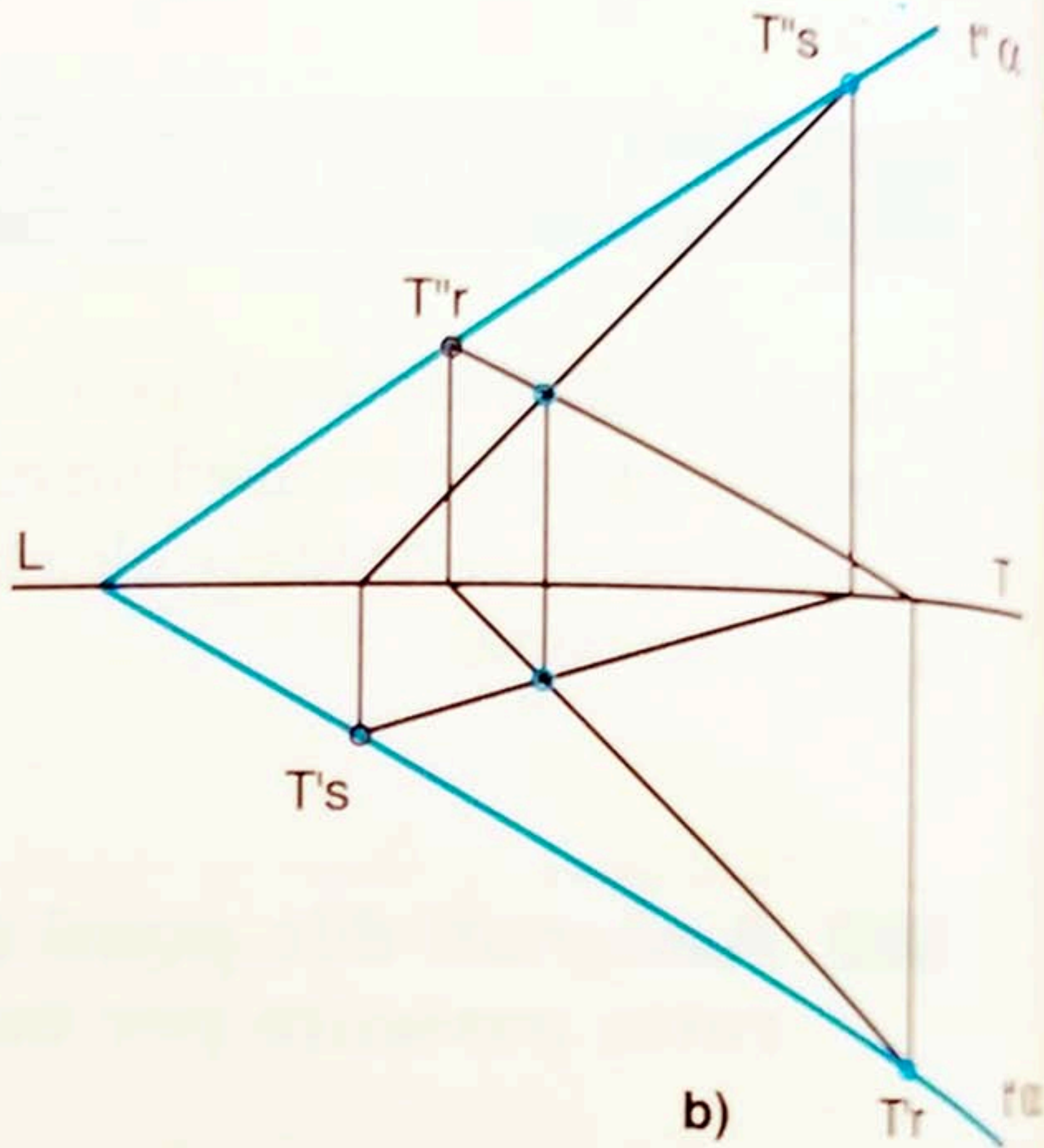

b)

1

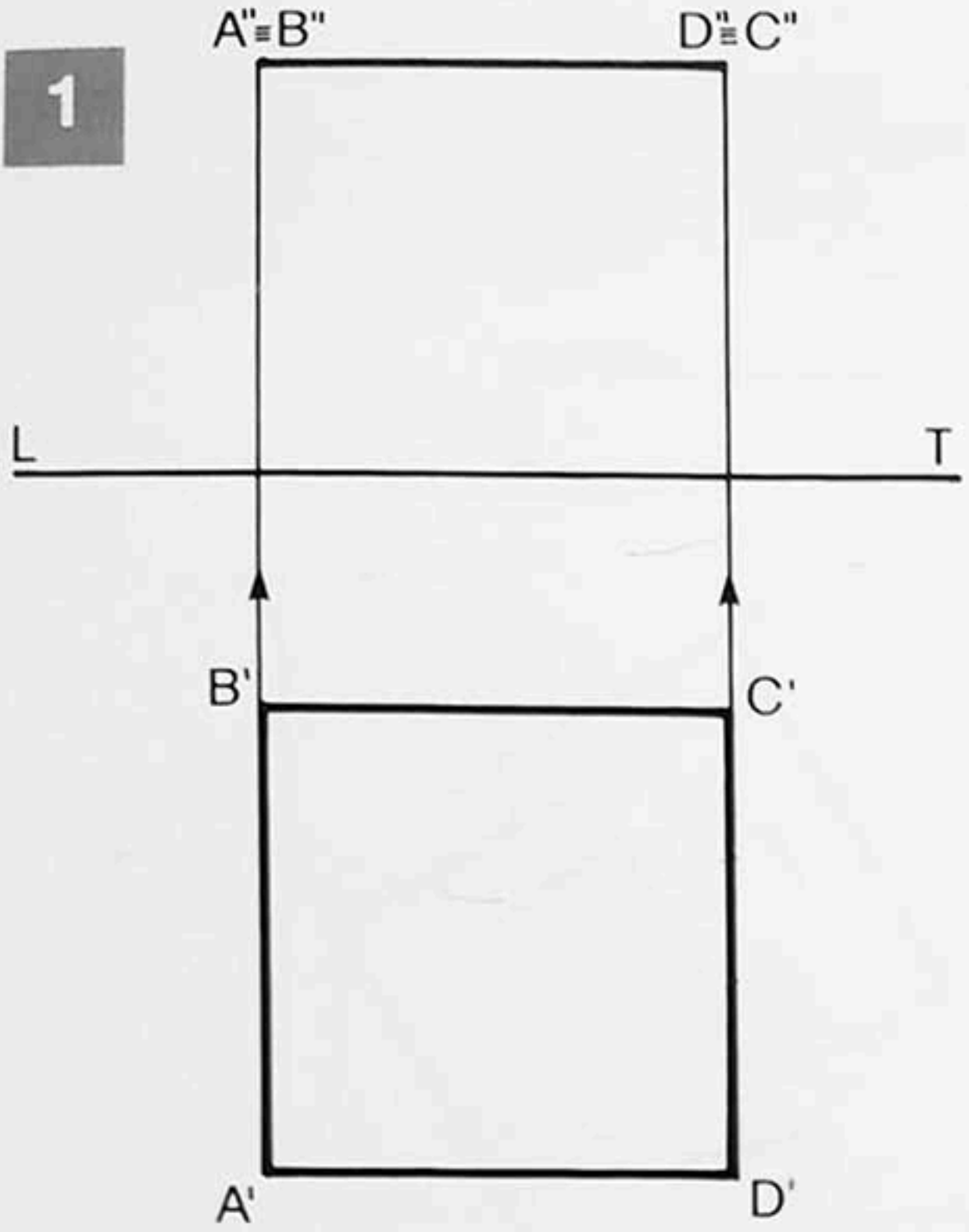

π_2

2

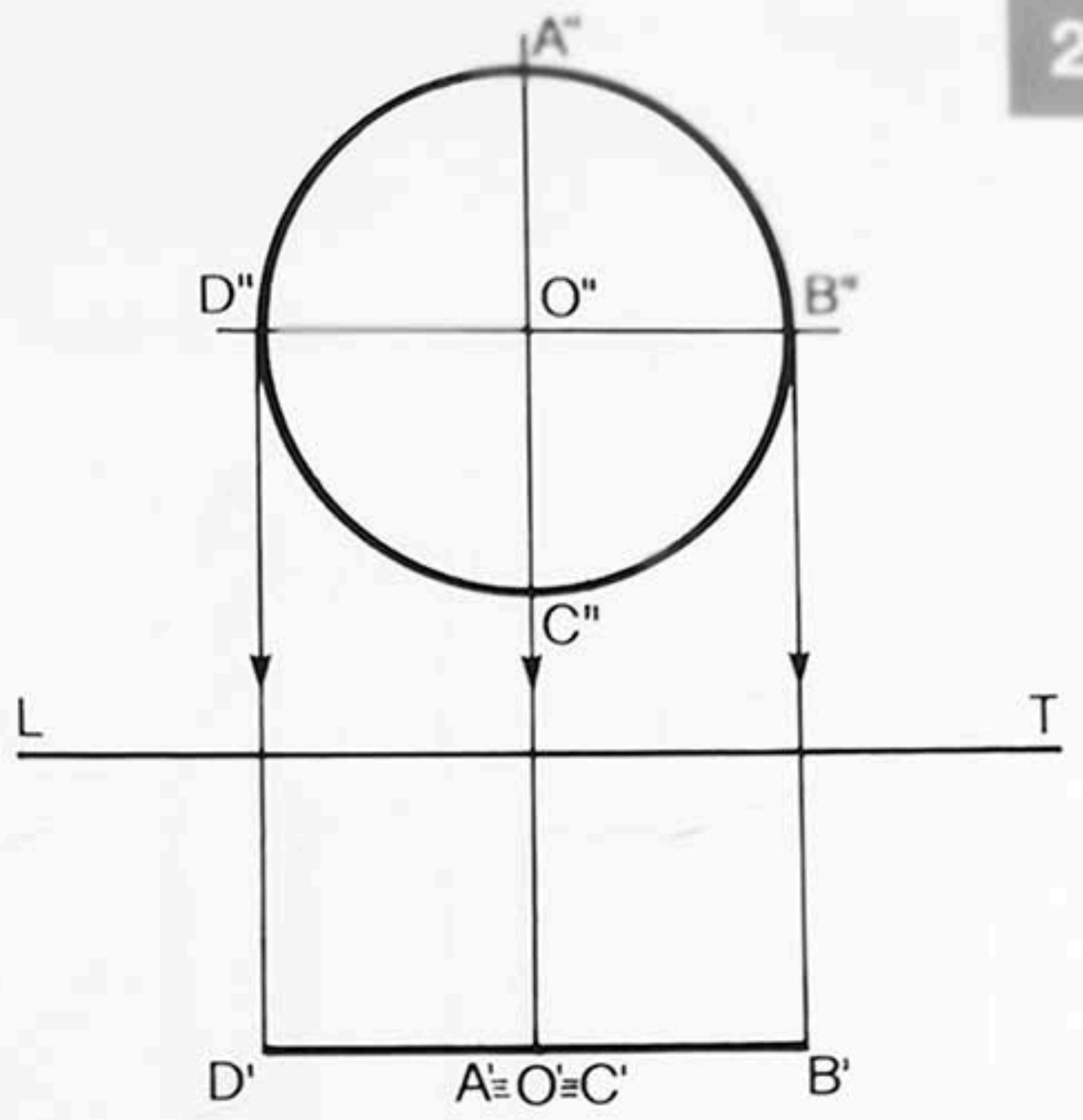

π_1

Doppia Proiezione ortogonale di un quadrato parallelo a π_1 e di un cerchio parallelo a π_2

Doppia Proiezione Ortogonale di un parallelepipedo:

parallelo a π_2 ; parallelo a π_2 e ruotato di 45° rispetto a π_1 ; ruotato di 30° rispetto a π_2 .

